



UNIVERSITY OF CRETE
FACULTY OF SCIENCES & ENGINEERING
DEPARTMENT OF MATHEMATICS & APPLIED MATHEMATICS
POSTGRADUATE PROGRAM "MATHEMATICS AND ITS APPLICATIONS"



Master Thesis

*The Antikythera Mechanism: historical review, current
understanding and educational potential*

Marinos S. Anastasakis
Supervisor: Ioannis D. Platis

HERAKLION
2013



ΠΑΝΕΠΙΣΤΗΜΙΟ ΚΡΗΤΗΣ
ΣΧΟΛΗ ΘΕΤΙΚΩΝ ΚΑΙ ΤΕΧΝΟΛΟΓΙΚΩΝ ΕΠΙΣΤΗΜΩΝ
ΤΜΗΜΑ ΜΑΘΗΜΑΤΙΚΩΝ ΚΑΙ ΕΦΑΡΜΟΣΜΕΝΩΝ ΜΑΘΗΜΑΤΙΚΩΝ
ΜΕΤΑΠΤΥΧΙΑΚΟ ΠΡΟΓΡΑΜΜΑ “ΜΑΘΗΜΑΤΙΚΑ ΚΑΙ ΕΦΑΡΜΟΓΕΣ ΤΟΥΣ”

Μεταπτυχιακή Εργασία

Ο Μηχανισμός των Αντικυθήρων: ιστορική αναδρομή, σύγχρονη
κατανόηση και εκπαιδευτικές δυνατότητες

Μαρίνος Σ. Αναστασάκης
Επιβλέπων Καθηγητής: Ιωάννης Δ. Πλατής

ΗΡΑΚΛΕΙΟ

2013

committee

Ioannis D. Platis

Paris Pamflos

Mihalis Kolountzakis

Abstract

In this thesis, we describe almost 100 years of research about the Antikythera Mechanism, from its accidental discovery in 1900 till nowadays. We present where the previous described efforts had brought us: how much really do we know about this strange artifact? Finally, we report on available physical and computer (simulations) models for the Antikythera Mechanism and its educational potential.

Keywords: Antikythera Mechanism, e-learning, education, mathematics education, simulations

Περίληψη

Στην παρούσα εργασία περιγράφουμε σχεδόν εκατό χρόνια έρευνας σχετικά με τον Μηχανισμό των Αντικυθήρων, από την τυχαία του ανακάλυψη το 1900 έως σήμερα. Παρουσιάζουμε που μας έχουν οδηγήσει οι πρωτότερες έρευνες: αλήθεια πόσα γνωρίζουμε για αυτό το αινιγματικό αρχαίο αντικείμενο; Τελικά, αναφέρουμε για τα διαθέσιμα φυσικά και ψηφιακά (προσομοιώσεις) μοντέλα του μηχανισμού των Αντικυθήρων και των εκπαιδευτικών δυνατοτήτων τους.

Λέξεις κλειδιά: Μηχανισμός των Αντικυθήρων, ψηφιακή μάθηση, εκπαίδευση, διδακτική των μαθηματικών, προσομοιώσεις

to my wife Effie
and son Stelios

PREFACE	8
PART I: HISTORICAL REVIEW	9
PART I: HISTORICAL REVIEW	10
1. Introduction	10
2. First Steps (1900-1948)	12
3. The Price Era (1951 - 1983)	19
4. Modern Times (1990 - 2012)	32
4.1 A Solitary Craftsman	32
4.2 Technology Boost	41
4.3 Latest Press	48
PART II: CURRENT UNDERSTANDING	57
5. The Fragments	57
6. Overall Design	60
7. Functions	62
8. Purpose and Maker	62
PART III: EDUCATIONAL POTENTIAL	64
9. e-Learning: An Introduction	64
9.1 How Do We Learn?	64
9.2 Software for Learning	67
9.3 An Interesting Assumption	69
9.4 Simulations: an educational prospective	70
9.5 Design Rules	71
9.6 E-learning guidelines	72
9.6.1 Multimedia Principles	74
9.6.2 Simulations and Games Principles	80

10. Antikythera Mechanism models	84
10.1 Physical Models	84
10.2 Simulation Models	88
11. Educational Potential	91
11.1 Mathematics Education	93
12. Are current simulations proper for educational purposes?	100
11.3 Justifying the observed oversights	109
12. Discussion and suggestions	111
13. Conclusion	112
APPENDIX - Ancient Astronomy	114
A. THE METONIC AND CALLIPPIC CYCLE	114
B. SIDEREAL, SYNODIC, TROPICAL, ANOMALISTIC AND DRACONIC MONTHS	115
C. SAROS AND EXELIGMOS CYCLES	116
D. ZODIACAL AND SOLAR ANOMALY	117
Bibliography	118

PREFACE

The story of the Antikythera mechanism is above all a story about people. People who tried to encode the heavens in a small wooden box and people who 2000 years later are still struggling to unlock its secrets. Therefore our story describes not only the attempts made by the latter to understand how the mechanism was actually working and its initial purposes but also their thoughts, passions and interactions. For us one thing is sure: the potential of the human mind is maybe infinite although it would be needed a lot of discussion about what infinite is.

In **Part I: Historical Review** we describe almost 100 years of research about the mechanism, from its accidental discovery till nowadays. Our main focus was to “depict” as much as possible the main breakthroughs made by leading scholars during the last century. This part is divided into three sections, with each one characterized by its protagonists and the technology status of each period.

In **Part II: Current Understanding** we present where the previous described efforts had brought us: how much really do we know about this strange artifact?

Finally **Part III: Educational Potential** reports on available physical and computer (simulations) models for the Antikythera Mechanism and its educational potential. Moreover we demonstrate that current Antikythera Mechanism simulations are not suitable for use in educational contexts. In addition, we identify another factor that affects the mechanism’s educational potential: restrictions of solid models. At the end of this part we discuss our findings and propose directions for future work.

I

HISTORICAL REVIEW

PART I: HISTORICAL REVIEW

1. Introduction

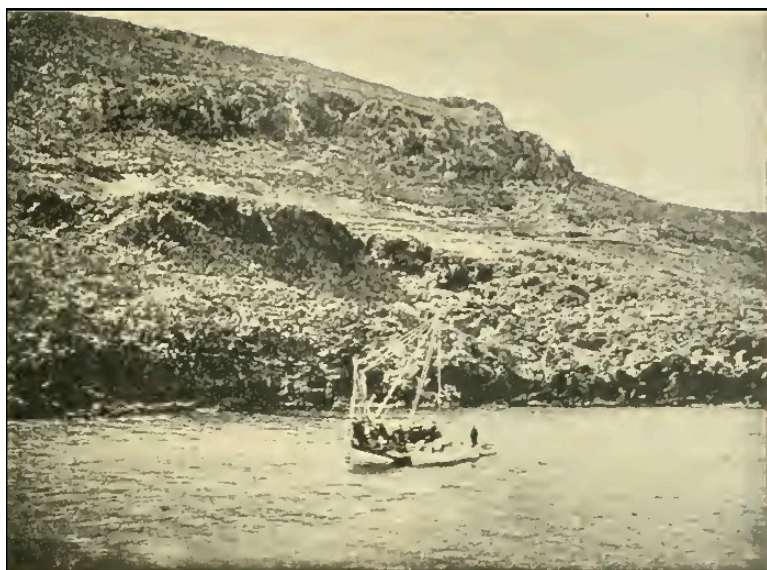

Fig.1: The Antikythera wreckage place (Svoronos, 1903)

The Antikythera wreckage and its precious findings were accidentally discovered by Greek sponge divers at the early 1900's, in particular at Easter of 1900. A team of sponge divers from the Greek island of Symi, were forced due to bad weather conditions to spend some time near the Antikythera island, while returning from their journey at the northern side of Africa¹ (Svoronos, 1903). Since their arrival the weather calmed down and the captain Dimitrios

Kontos decided to order his crew to dive for finding sponges.

A diver named Elias Stadiatis at his first attempt found the wreckage of a ship in depth of 35 fathoms (64 meters), surrounded by scattered pieces of bronze and marble statues (Svoronos, 1903). After finding the wreckage, the captain consulted the council of Symi elders who finally decided to announce to the Greek government their findings. The excavation of the Antikythera wreckage lasted for almost a year, from 24th of November of 1900 to 30th of September of 1901. The operations were continuously disrupted by the unstable weather and the difficulties that the divers had to deal with, since the equipment of those days was enabling them to spend only five minutes underwater per dive in relative small depths.

Unfortunately a diver died and two others became disabled during the operations. In

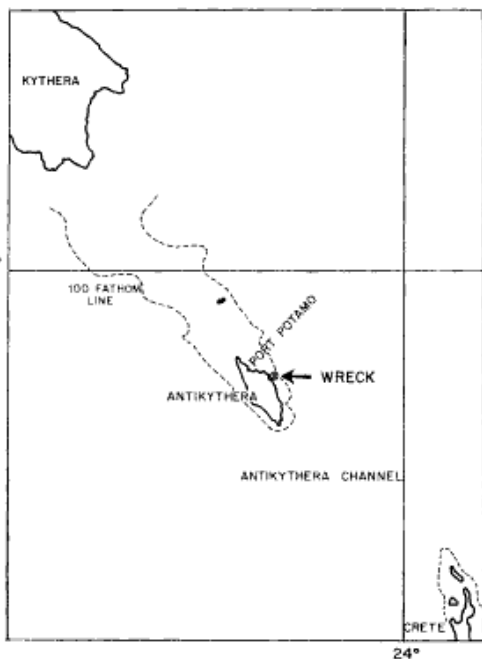

Fig.2: The position of the wreck (De Solla Price, 1974)

¹ According to the tradition, the season for sponge divers was starting during spring time. John Svoronos did a mistake; the sponge divers were going to Africa not coming back. For more details see [ΙΕΡΑ ΜΗΤΡΟΠΟΛΙΣ ΣΥΜΗΣ](#).

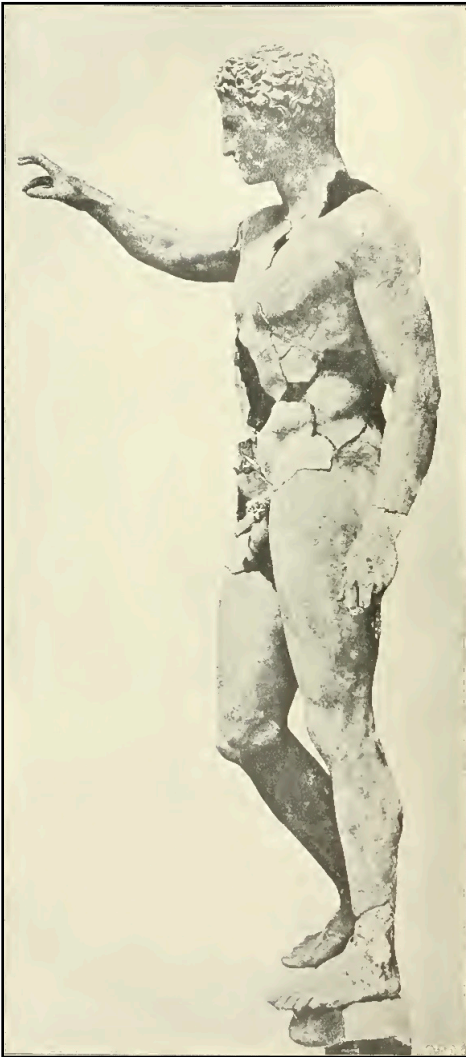

Fig.3: The Antikythera Youth at early stages of reconstruction (Svoronos, 1903)

In addition the Greek government asked help from French and German divers but still the undertaking was difficult to be accomplished. After excavating the main body of the wreckage, Greek government decided to cease the operations and the artifacts were transferred to the National Museum of Athens for restoration.

The findings of the Antikythera wreck were of great importance because it was the first time that archaeologists discovered so significant and in great amounts artifacts of the ancient Greece; among the findings are included the famous Antikythera Youth statue and the philosopher's head. It is important though for our purposes to point out that after the wreck's finding the main body of conducted research was focused on the statues, coins and other artifacts. The Antikythera mechanism was still remaining unnoticed and decaying somewhere at the courtyard of the National Museum of Greece. The mechanism was found accidentally when a worker noticed the strange object and reported to Valerios Stais, the museum's director (Marchant, 2010a). He was the first person who pored the mechanism and understood its significance.

At the following sections we are going to present the relevant research on the Antikythera mechanism, from 1903 to nowadays. Our major scope is not to review the literature in depth but rather "reconstruct" the events that led to our current understanding. We divided the conducted research into three main periods:

1. First Steps (1900 - 1948)
2. The Price Era (1951 - 1983)
3. Modern Times (1990 -)

During the study of the relevant literature it was obvious to us that there were certain factors that drove the research in the field; the **acknowledgment** of the artifact, the **bias** towards the mechanism's purpose and the **technology** used to unveil the artifact's secrets. In other words, the research was affected by what scholars were thinking about the Antikythera mechanism and by the ways that they used technology to overcome the corrosion made by the long stay under the sea surface.

2. First Steps (1900-1948)

After it was transferred to the National Museum in Athens, the Antikythera mechanism remained in darkness for about eight months until a worker noticed it and reported to the museum's director Valerios Stais. By noticing the mechanism's gearwheels Stais concluded that this sophisticated artifact was a device for making accurate calculations and measurements. After spending some time studying the ancient mechanism, Stais realized that his knowledge was far beyond the required for decoding the mechanism's secrets and decided to call two experts for help (Marchant, 2010a): John Svoronos and Adolph Wilhelm.



Fig.4: John Svoronos (1863-1922)

John Svoronos was the director of the National Numismatic Museum in Athens and an expert in reading ancient lettering while Adolph Wilhelm was an Austrian expert in inscriptions stationed in Athens at that time (Marchant, 2010a). Wilhelm's contribution was to date the artifact somewhere between the second century BC and the second century AD while Svoronos with other Greek scholars during 1902 (Konstantin Rados and Pericles Rediadis) were debating about the mechanism's date, origin and purpose in the national press².

In 1903 Svoronos published "To En Athinais Ethnikon Mouseion" in which he reported in detail the Antikythera findings and some first thoughts on the Antikythera mechanism written with the sublieutenant Pericles Rediadis, professor of geodesy and hydrography. Svoronos and Wilhelm's decipherment of 220 Greek letters helped the two scholars to date the artifact somewhere at the first half of the third century BC and to postulate that the finding was a mechanical astrolabe (Rediadis, 1903).

This report, although vague, is the first technical description of the artifact. It is divided

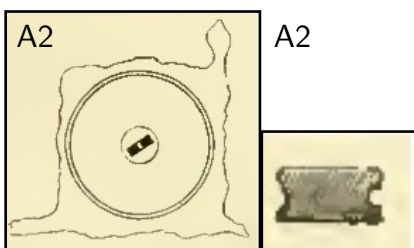

Fig.5.1: Rediadis' drawings (Rediadis, 1903)

into three parts; in the first part Rediadis describes each of the mechanism's four main fragments which are named as A, B, C, and D (Fig.5.2) where 1 and 2 stands for the two sides of each fragment and proceeds by making some remarks on the mechanism's lettering which are engraved at pieces B1 and C1. Rediadis points out the significance of the partial readable inscription of the word "[μοιρο]γνωμό

² A list of these articles can be found at Svoronos 1903, pages 15-16 footnote 1.

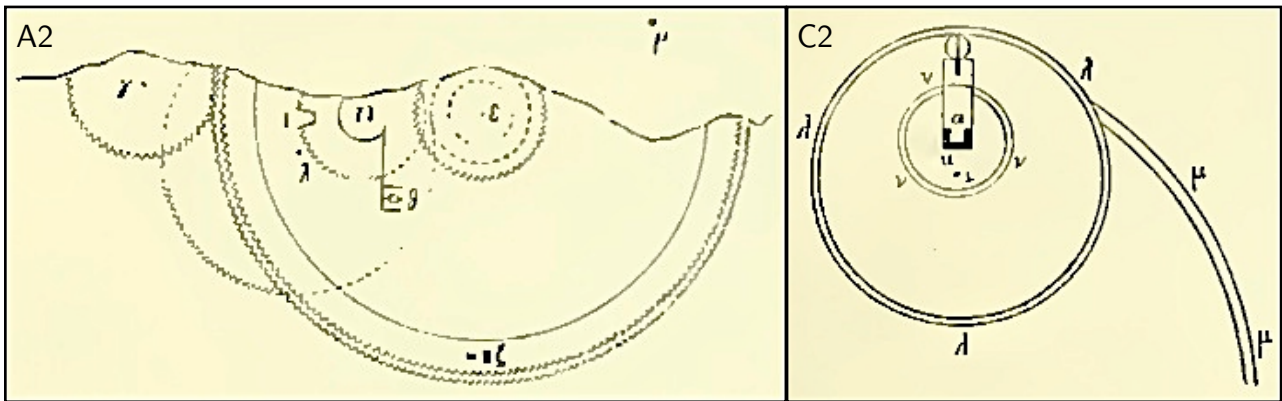

Fig.5.2: Rediadis' drawings (Rediadis, 1903)

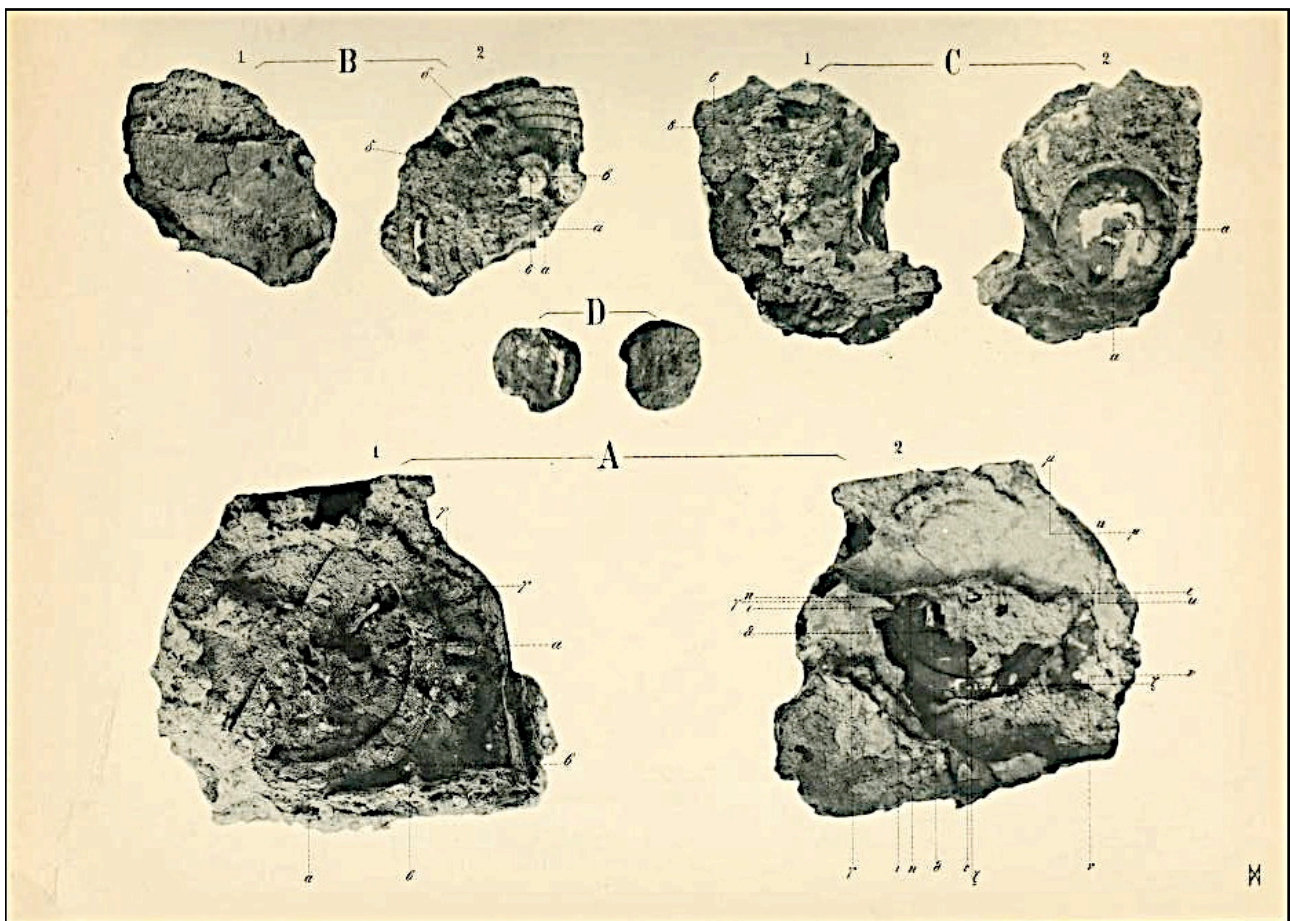

Fig.5.3: The Antikythera Mechanism, first pictures from the complementary book of indexes (Svoronos, 1903)

[νιον]” (means graduated scale and was used to describe the zodiac scale) and the existence of two stand alone letters engraved at the mechanism’s surface; these were the letter T and a letter that looks like an incomplete H (Eta). The major points made by Rediadis are the following (Rediadis, 1903):

- ▶ The mechanism was “housed” into a wooden box with instructions of use engraved on the artifact just like modern navigational instruments; as a result it might was one of the ship’s instruments.

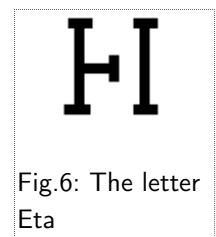

Fig.6: The letter Eta

- ▶ The incomplete H might stand for the sign of Aquarius or as the monograph or signature of the maker.
- ▶ The letter T might was a sign to help the user to dismantle the mechanism.
- ▶ The date of the artifact's era was estimated by dating the letters of the inscriptions (Svoronos and Wilhelm).
- ▶ Even if the mechanism wasn't a part of the ship's navigational instruments, there is no other instrument from ancient times that can "approach" the mechanism's complexity.
- ▶ The recognized words **[μοιρο]γνωμό[νιον]** , **Αφρ]ροδίτης** (Venus), **ηλίου ακτίνα** (sun radius), **ήλιον** (sun) suggest that the mechanism was used as an astronomical instrument. In particular the word "μοιρογνωμόνιον" suggests the zodiac scale.
- ▶ Since the only know astronomical instrument at ancient times was the astrolabe, the artifact must be some kind of mechanical astrolabe. Its gearwheels could be used for entering the season, the observer's geographical latitude and the star's altitude for calculating the position triangle (astronomical triangle).

Two years later, in 1905, a naval historian named Konstantin Rados published a paper arguing that the Antikythera mechanism is far too complex to have been an astrolabe (Rados, 1905). For Rados was hard to believe that the mechanism was on the same ship cause of its complexity and he supposed that it must have been dropped there from a later shipwreck.

At the same year, Valerios Stais published an essay (Stais, 1905) where he agreed with Rediadis and others that the mechanism was unquestionably one of the ship's navigational instruments. Stais stated that his purpose was mainly to determine the wreck's date and not to argue furthermore about the artifact's purpose of use. By studying one of the fragments' lettering³, Stais concluded that the mechanism should be dated since the first century BC.

The disagreement among scholars continued and in 1907 Albert Rehm from the University of Munich went to Athens to study the artifact since Rediadis' description and photos were poor. When Rehm reached Athens the mechanism's fragments were carefully cleaned and he was able to read a previously hidden word: Pachon (ΠΑΧΩΝ), the Greek name of a month in the ancient Egyptian calendar (Marchant, 2010a). Rehm argued that since there is no use for months names on an astrolabe, the artifact couldn't be an astrolabe nor any kind of navigational instrument as Rediadis had suggested. In addition he claimed that the mechanism was certainly ancient (opposed to

³ Stais based his conclusions by studying the Greek letters Α (alpha), Ε (epsilon), Π (pi), Σ (sigma) and Ω (omega) on the fragment B1 (Fig: 5.3)

Rados' opinion) but it was too complexed to be an astrolabe (Rehm, 1907). For Rehm the mechanism should be some kind of ancient planetarium for calculating the precise positions of the Sun and the known planets at the time (Mercury, Venus, Mars, Jupiter and Saturn).

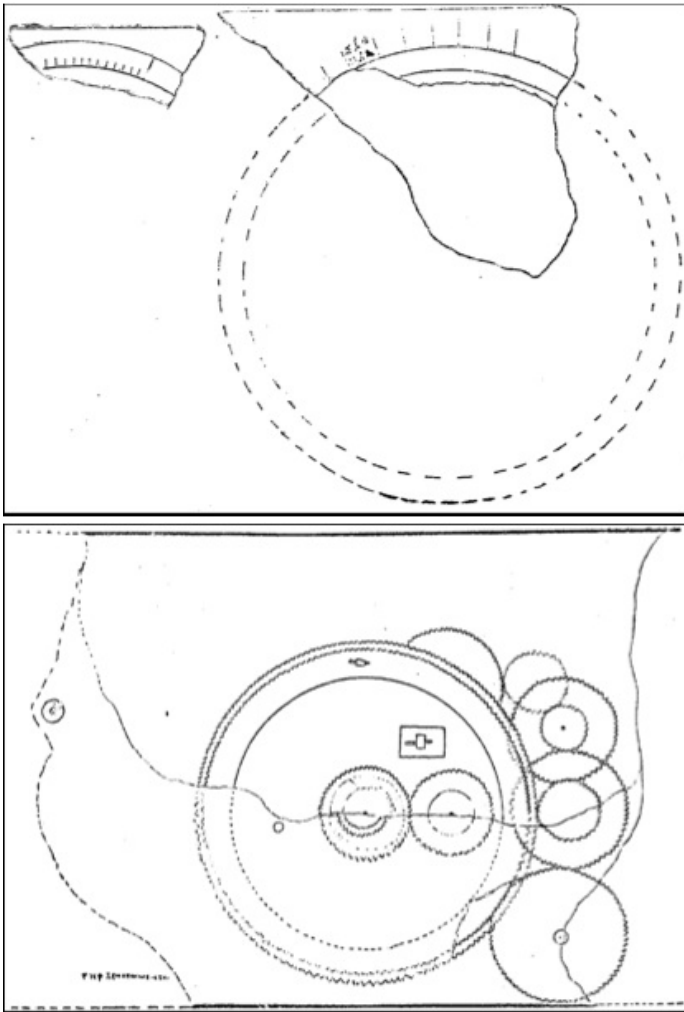

Fig. 6: Rados' drawings (Rados, 1910)

Although Rehm worked sporadically on the fragments for the next decades he never managed to publish his work; he died in 1949 and his manuscripts and mechanism's photos laid in ignorance, until Price had the chance to look at them many years later (De Solla Price, 1974).

Three years later in 1910, Rediadis opposed to Rehm's opinion by arguing that even there is a possibility that the Antikythera mechanism isn't an astrolabe, it is less reasonable to be a planetarium since the mechanism is flat and the gears are too weak to support a spherical device like a planetarium (Rediadis, 1910). He also repeated his argument that the object must have been one of the ship's navigational instruments (Marchant, 2010a). In addition the article included a chemical analysis of the metal fragments (De Solla Price, 1974).

1974).

At the same year Konstantin Rados published a booklet about the artifact where after describing the mechanism, he compared it with astrolabes, planetariums and distance-meters (odometers) in order to justify his points which are the following (Rados, 1910):

- ▶ The mechanism can't be an astrolabe since traditional astrolabes have no gears.
- ▶ It can't neither be a flat navigational astrolabe since if the mechanism's date is correct (first century BC), flat astrolabes were not invented yet.
- ▶ Albert Rehm's point to consider the mechanism as a planetarium is correct.

Unfortunately, for the next twenty years research on the field stalled and only minor articles were published repeating previous ones (De Solla Price, 1974; Marchant,

2010a). These were by Herman Diels⁴ in 1920, A. Schlachter⁵ in 1927 and Robert Gunther⁶ in 1932.

However during the 1920s John Theophanidis, a Rear-Admiral in the Greek navy, got interested in and investigated the mechanism furthermore. He published his findings in *Praktika tes Akademias ton Athenon* (1934) in conjunction with an article by K. Maltezos. The latter reviewed only in short the prior literature (Maltezos, 1934) while Theophanidis extended the deciphered letters by Svoronos to 350 (De Solla Price, 1974) and in contrast with his colleagues, proposed a reconstruction by noting that (De Solla Price, 1974; Marchant, 2010a; Theophanidis, 1934):

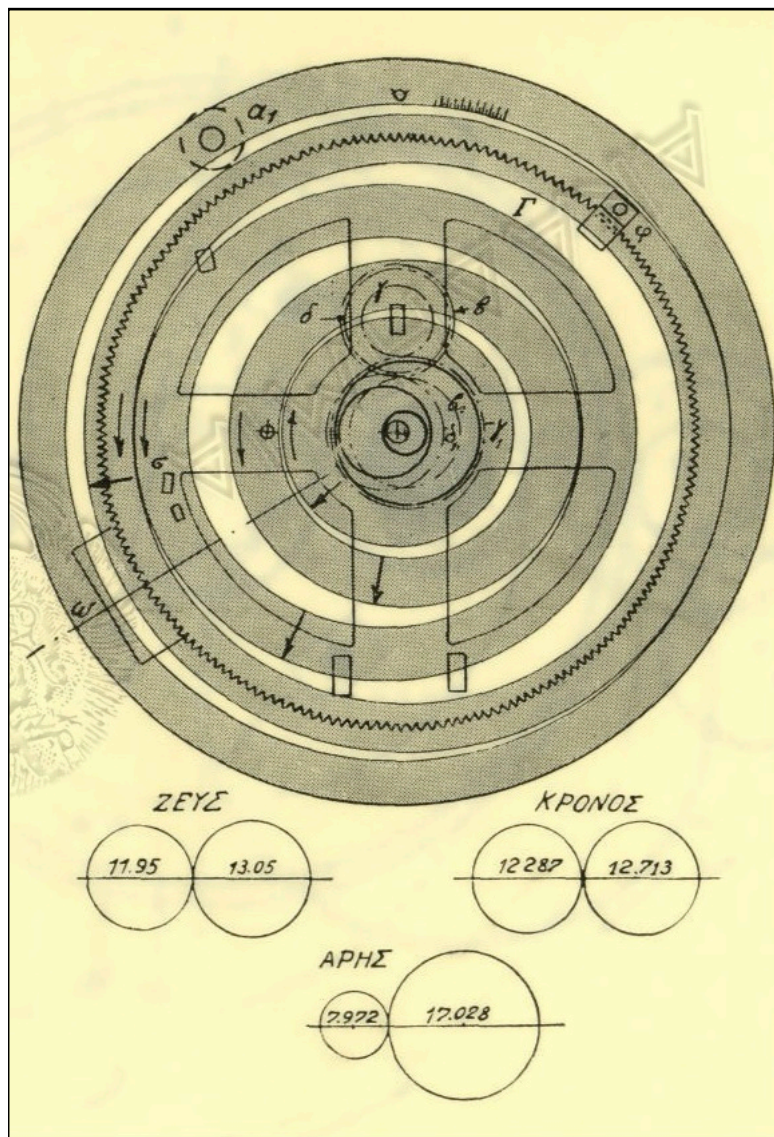

Fig. 7: Part of Theophanidis' proposed reconstruction (Theophanidis, 1934)

⁴ (Diels, 1920)

⁵ (Schlachter, 1927)

⁶ (Gunther, 1932)

- ▶ The engraved letters are so precise that they must have been done by a highly trained craftsman.
- ▶ The mechanism was indeed a navigational instrument and was used for calculating the accurate positions of the Sun, Moon and planets as Rehm (1907) had suggested.
- ▶ The Sun, Moon and planet's movement was produced by carefully chosen ratios among the gears' teeth.
- ▶ By placing a nail in the middle of the concentric circles and adjusting certain gears, the user could calculate the ship's orientation.
- ▶ The device was an astrolabe that could work in conjunction with a ruler and a compass for solving astronomical and nautical problems.
- ▶ The cleaned front face of the main fragment revealed a graded scale, maybe the zodiac scale referred to the inscriptions with the word "μοιρογνωμόνιον" (Fig.8 and Fig.9).

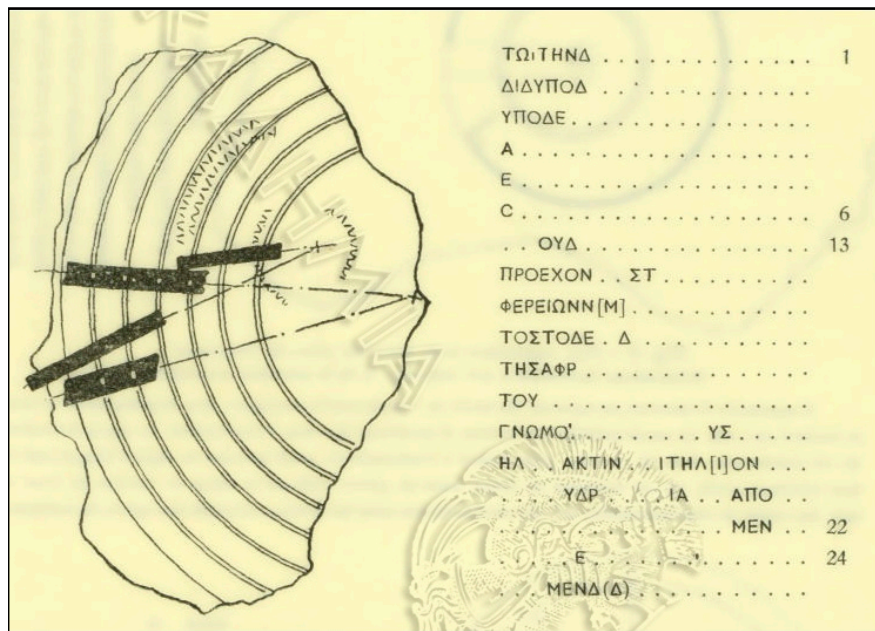

Figure 8: Part of Theophanidis' proposed reconstruction (Theophanidis, 1934)

Although Theophanidis didn't support all of his arguments on evidence, the article added new information about the artifact (De Solla Price, 1974) and his drawings were by far more sophisticated. He continued to work obsessively and he managed to built a model but without publishing anything again (Marchant, 2010a).

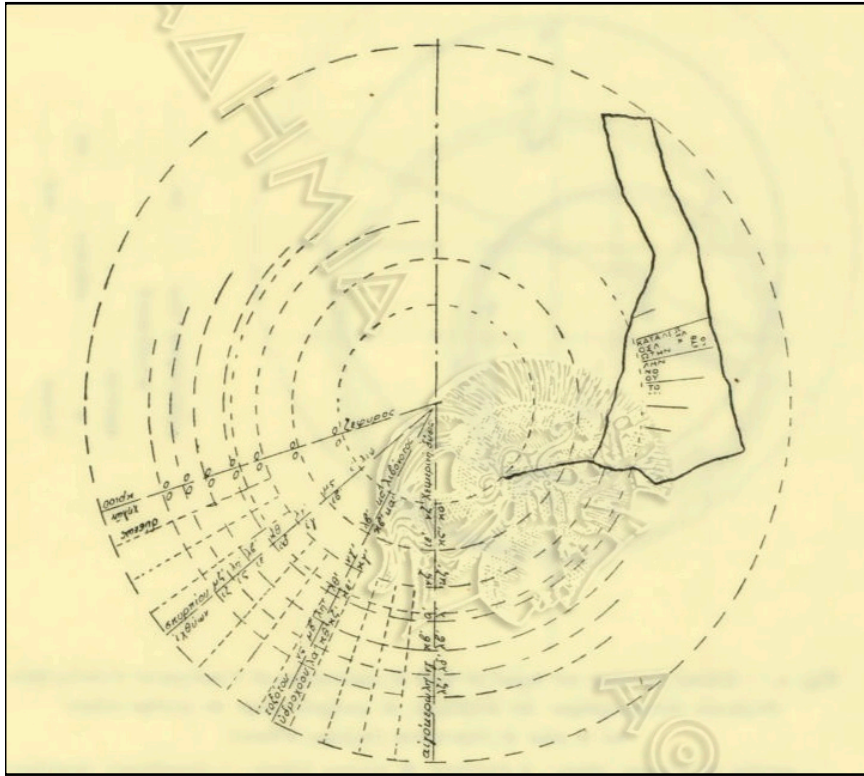

Figure 9: Part of Theophanidis' proposed reconstruction (Theophanidis, 1934)

During the next years the same pattern occurred as prior to Theophanidis' publication. Price (1974) mentions three other scholars that entered the arena but didn't manage to contribute furthermore to the research: Willy Hartner⁷, Ernst Zinner⁸ and George Karo⁹.

Until the end of Second World War the research community was only speculating about the mechanism's purpose and use (Marchant, 2010a). The only certain facts were that the artifact was a Greek invention, it was dated since the first century BC and its general purpose was probably astronomical (as the words "Pachon" and "μοιρογνωμόνιον" suggested).

The next period (1951 - 1983) engages a great scholar, Derek De Solla Price; he both managed to bring back to the spotlight the Antikythera mechanism and unveil more secrets of this two thousand year old analogue computer.

⁷ (Hartner, 1939)

⁸ (Zinner, 1943)

⁹ (Karo, 1948)

3. The Price Era (1951 - 1983)

Although the second period is named after Derek De Solla Price who initially became interested in 1951, during these years other scholars and scientists managed to collect and understand more pieces of the puzzle by adopting a different approach. In particular, they didn't examine the mechanism itself but the context of the artifact, that is the Antikythera wreckage. In this section we firstly present the findings of the latter case and then we proceed with the pioneering research of Price.

Undersea explorers like Jacques Cousteau and Frederic Dumas were the first that visited the wreck site after the initial one back in the 1900's. Their first visit with the famous Calypso was in 1953. Cousteau and Dumas' high-tech diving equipment allowed them to dive deep but their findings were poor (a few fragments of pottery). Dumas' persistence alongside with a newly developed suction pump finally led them to the discovery of the 2.000 years old ship that carried the Antikythera mechanism. Dumas described the expedition in his 1972 book (in French), *30 Centuries under the Sea* (Dumas, 1976). Since their scheduled time was limited they decide to pay another visit later; unfortunately this visit was going to occur only after 23 years.



Fig.10: An amphora from the Antikythera wreck (Weinberg et al., 1965)

In 1954 a Greek young graduate called Maria Savvatianou was working in Athens with an American archaeologist, Virginia Grace: they were trying to catalogue 25.000 broken amphora handles originated from various sites across the Mediterranean Sea. Savvatianou came across with Svoronos's publication and had the idea to date the Antikythera amphoras by comparing them with the ones of their catalogue (Marchant, 2010a). Virginia Grace gathered some friends and colleagues in order to study the glass, pottery and wood fragments from the wreckage: Henry Robinson (director of the American School of Classical Studies in Athens and early Roman pottery specialist), Roger Edwards (Greek Hellenistic pottery specialist from the University of Pennsylvania), Gladys Weinberg (glassware specialist from the University of Missouri) and Peter Throckmorton (journalist and archaeologist).

Each member of the team studied various objects¹⁰ from the wreck accordingly to their speciality. In particular, Virginia Grace studied the commercial amphoras, Henry Robinson the early Roman pottery, Roger Edwards the Hellenistic

¹⁰ Studied artifacts consisted of cargo objects transferred to Rome and everyday objects used by the ship's crew.

pottery, Gladys Weinberg the glass vessels and Peter Throckmorton fragments of the ship. With the help of Elizabeth Ralph who ran a Carbon-14 dating test at the University of Pennsylvania, they published their findings at a joint paper almost a decade later, in 1965. Specifically they concluded that (Weinberg et al., 1965):

- ▶ the ship had been built by the Romans;
- ▶ the wood from the ship's fragments dated from between 260 and 180 BC;
- ▶ the ship was a large cargo vessel, 30 to 40 meters long;
- ▶ the ship started its journey from somewhere on the Asia Minor coast between 86 and 60 BC sailing towards to Rome, loaded with loots.



Fig.11: The stack of coins
(Cousteau, 1978)

In 1976 Cousteau and Dumas returned to the wreck site equipped with more advanced and sophisticated equipment. Although they searched and mapped every square meter of the wreck site, their findings were poor in comparison with those obtained during the initial operation during the 1900's. Cousteau hopped to find missing pieces of the Antikythera mechanism but the most significant object discovered was a stack of fused coins that helped archaeologists to date the wreck: the ship had sunk somewhere between 70 and 60 BC and probably had started its journey from the city of Pergamon, as the coins indicated. Among others the divers obtained two small bronze statues, a human skull, some giant ship nails, an oil lamp, and an ornate gold cap (Marchant, 2010a). Cousteau filmed a dedicated episode in the TV series "The Cousteau Odyssey" entitled "Diving for Roman Plunder" that was firstly broadcasted in 1978.



Fig.12: Price in 1948.

Let us now go back again in 1951, where Price began to consider that the Antikythera mechanism is of great importance and started studying the papers of Gunther, Svoronos and Zinner (De Solla Price, 1974). By 1953 Price had the opportunity to examine the newest photographs of the strange artifact, provided by the director of the National Archaeological Museum of Athens, Dr. Christos Karouzos. The condition of the Antikythera mechanism had changed since 1948, as the restoration process had revealed a more detailed view, previously unavailable due to the mechanism's corrosion. Based on these photographs Price published an article, "Clockwork before the Clock" (De Solla Price, 1955)

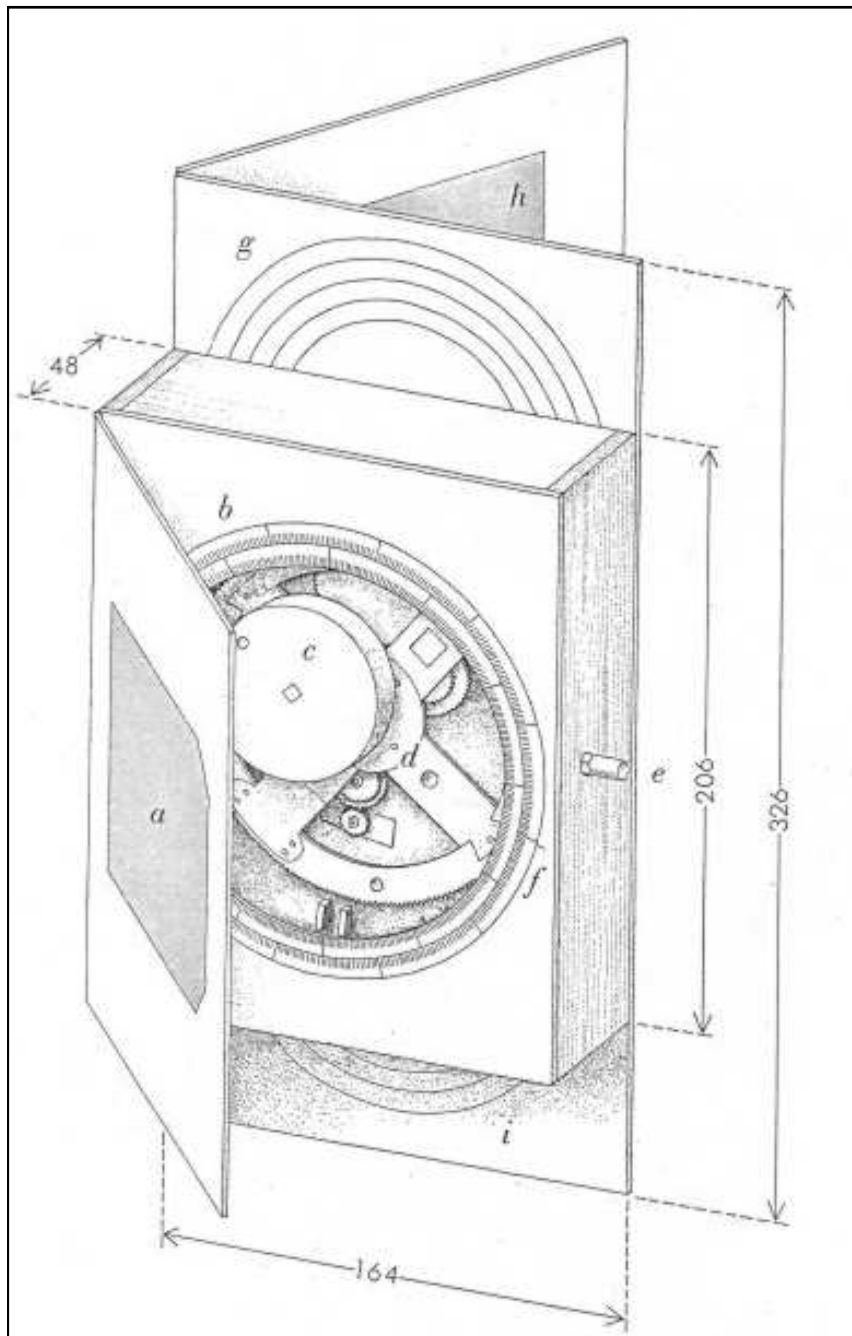

Fig.13: Price's partial reconstruction: front-door inscription (a), front dial (b), eccentric drum (c), front of mechanism (d), input shaft (e), fiducial mark (f), four slip rings of upper back dial (g), back-door inscription (h), three slip rings of lower back dial (i) The dimensions are given in millimeters. (De Solla Price, 1959).

but even so, his findings were still restricted by the fact of examining 2-D representations of a 2.000 years old relic.

In 1958 after receiving a grant from the American Philosophical Society, Price had the opportunity of visiting Athens and examining closely the artifact. Almost immediately in 1959 he published an article for the Scientific American magazine (De Solla Price, 1959). At this article he argued about the significance of the mechanism and stated that its encapsulated scientific and technological knowledge could change by far our

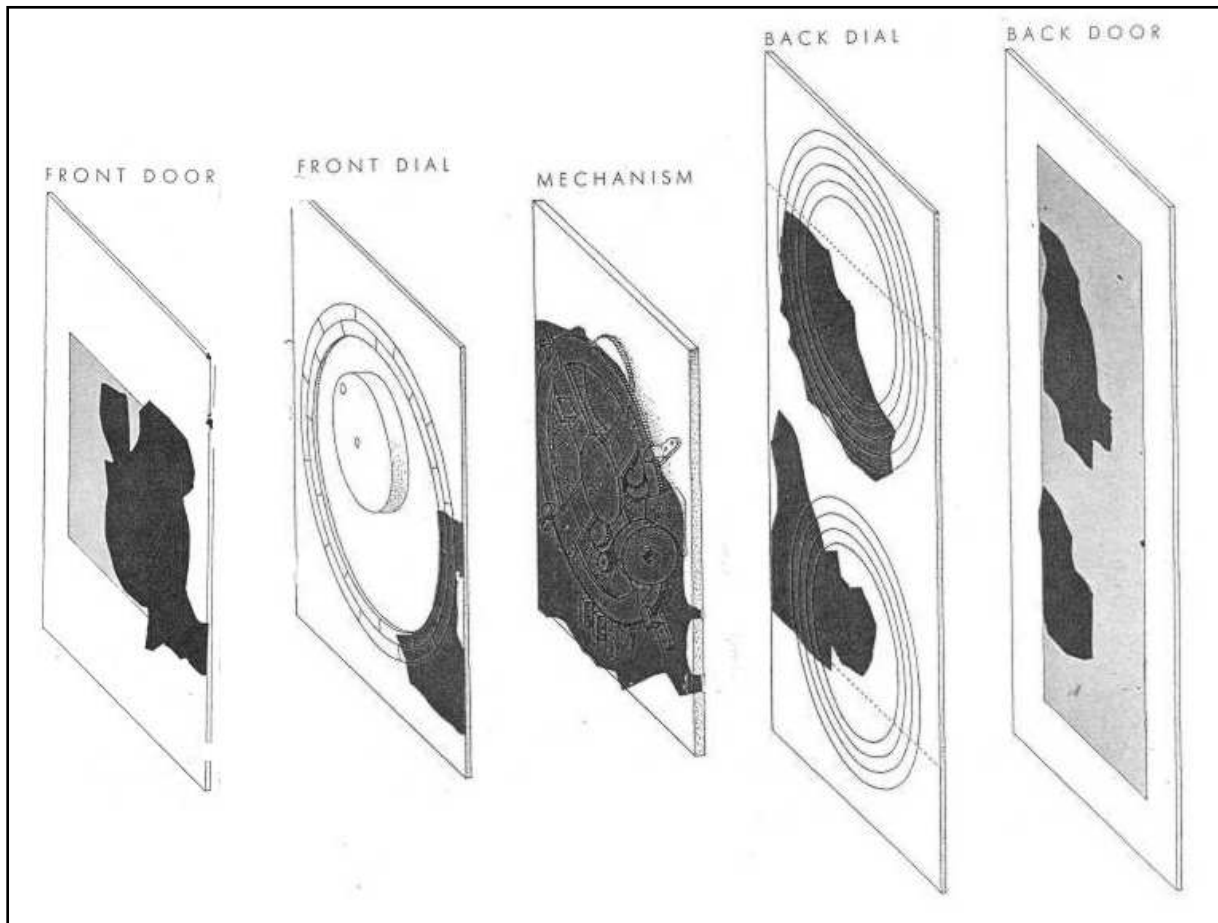

Fig.14: Mechanism's layers and survived fragments (De Solla Price, 1959).

conventional understanding of Greek science, since ancient Greeks were thought to be great philosophers and not technology experts.



Fig.15: George Stamiros working on the inscriptions (Lazos, 1994)

With the help of Dr. George Stamiros, a Greek epigrapher who deciphered 800 letters, Price concluded that the mechanism's fragments were found nearly in their original place "packed" together and not squashed and distorted as previously considered by scholars. He managed to partially reconstruct the mechanism (Fig.13) and to identify the "layers" from which several fragments had survived. These were the front door, the front dial, the mechanism, the back dial and the back door (Fig. 14). In addition, he founded traces which indicated that the artifact had been twice repaired and thus the machine was actually working and wasn't just a model.

Although other articles were published by Price, this was the first major one. After revisiting Athens in 1961, Price continued to work his way out but without making any

progress. By 1965 when Gladys Weinberg and her colleagues published their findings on the Antikythera wreck, Price was still at the same point he was 6 years ago. The eroded relic was by far complex and firmly “packaged” to allow further analysis. In 1971 the fruitful outcomes of the previously established Atomic Era, gave Price the tools to go



Fig. 16: Dr. Karakalos working at his laboratory (Lazos, 1994)

beyond of what the human eye perceives: he came across with an article published by researchers at the Oak Ridge National Laboratory in Tennessee (Miller, Sayre, & Keisch, 1970), describing a method of using gamma rays for examining art and archaeology objects. He instantly thought of using this technique in order to “penetrate” inside the Antikythera mechanism and for that reason he contacted Alvin Weinberg, director of Oak Ridge, asking him about the possibility of using the technique on the mechanism’s fragments (Marchant, 2010a). Weinberg directed him to the Greek Atomic Energy Commission and finally Price started collaborating with a Greek nuclear physicist, Dr. Charalambos Karakalos (De Solla Price, 1974).

Karakalos and his wife Emily spent the summer of 1972 in taking gamma-radiographs, x-radiographs and counting the revealed teeth of the mechanism’s gears.

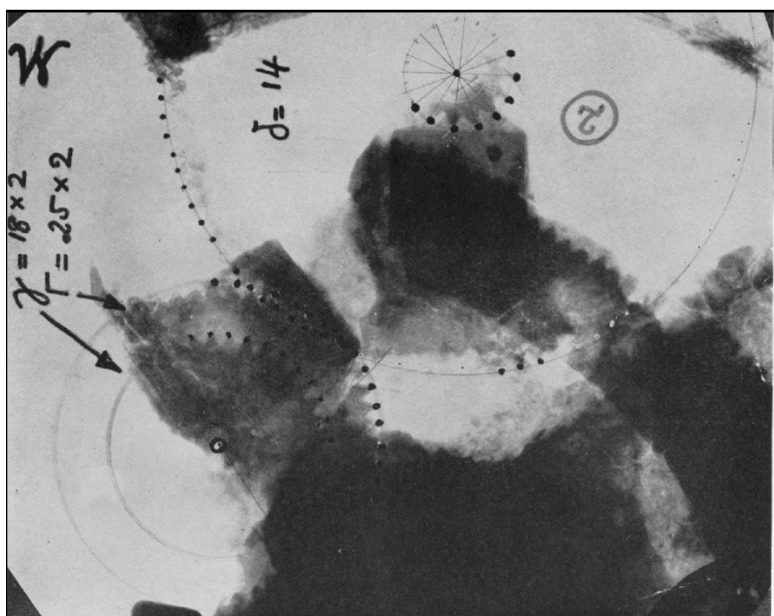

Fig. 17: Gear tooth-count process (De Solla Price, 1974)

Price was on sabbatical leave in Europe and visited Athens twice during that summer. He was checking the progress and studying the new features that the radiographs had revealed: up to eight layers of overlapping gearing and teeth (Marchant, 2010a). Luck also helped Price and Karakalos: within the museum’s storage a fragment was found, fragment D, which helped them to purpose a more solid reconstruction. After the counting was finished, Price

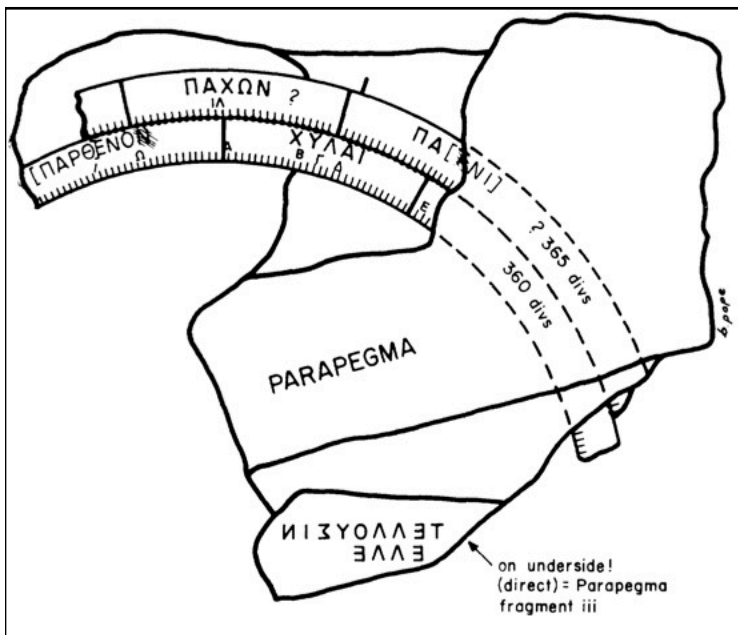

Fig. 18: Front dial diagram (De Solla Price, 1974)

returned back to Yale shut doors and started working intensively. He thoroughly examined the front dial which was very clean and readable: he identified two scales: the outer was fixed and displaying the zodiac's signs and names while the inner one was movable, divided into 12 sections and displaying the months of the year. Stamires had read the word **ΧΥΛΑΙ** (Chelai: meaning claws), corresponding to the ancient Greek name for the constellation of Libra and the partial word **[ΠΑΡΘΕΝ]ΟΝ[ΟΥ]** indicating the preceding sign of **ΠΑΡΘΕΝΟΣ** (Virgo). On the outer scale Price read the name of the month **ΠΑΧΩΝ** (Pachon), as spotted by Rehm and the incomplete name of the month **ΠΑ[ΥΝΙ]** (Payni): these were two consecutive months of the Greco-Egyptian calendar

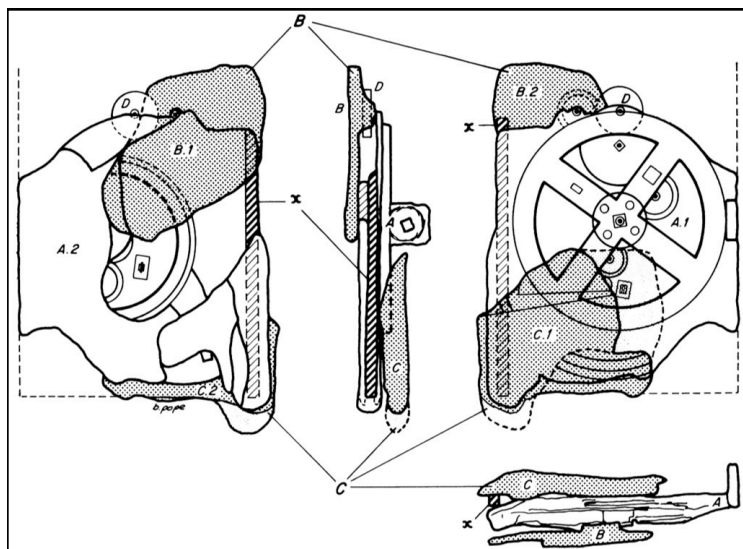

Fig. 19: Main fragments and their joints (De Solla Price, 1974)

which consisted of 12 periods of 30 days each.

By examining the radiographs, Price firstly argued as previously that the fragments were actually near their initial positions and not smashed under sea pressure (Fig. 19). He also confirmed that the small crown wheel drove the "Main Drive Wheel" (MDW) but was unsure if the crown was turned by hand with a handle or by other means, like the Tower of the Winds¹¹. Since the MDW was positioned directly behind the zodiac, Price concluded that MDW would have driven a pointer indicating the Sun's position. In particular by turning five times the crown would result a full turn of the Sun's pointer. Price recognized two gear trains and a third

¹¹ An octagonal marble clock tower located on the Agora in Athens. Built around 50 BC, it was a combination of sundials, a water clock and a wind vane.

undetermined one. Each sequence of gears had specific ratios. These were (Edmunds & Morgan, 2000):

1. Drive wheel to Moon position indicator: 254 sidereal months in 19 years (Fig. 20.1)
2. Drive wheel to differential turntable: The relationship of sidereal months to sidereal years (254:19) and their difference is used to determine the synodic cycle of the Moon (Fig. 20.2) and Differential output to synodic month: doubles the differential turntable output to 235 turns of the synodic month indicator for 19 turns of the drive wheel (Fig. 20.3)
3. Drive wheel to four-year dial: one turn of the drive wheel results in 1/4 turn of the N axle (Fig. 20.4)

1. Drive wheel to Moon position indicator

By examining the other gears Price speculated that a second pointer was present alongside with the Sun's but in order to find which celestial object represented, he needed to calculate first its relative speed to the Sun pointer. To do this he started by trying to correlate the tooth ratios of connected gears.

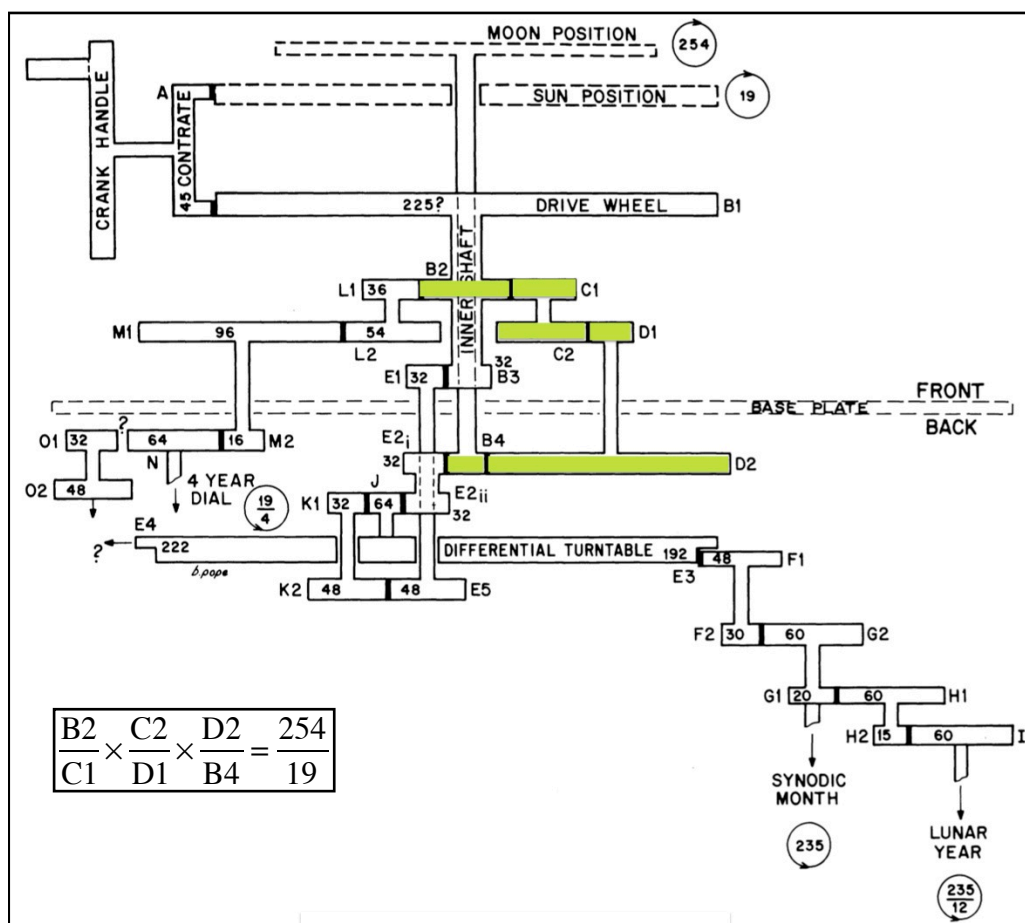

Fig. 20.1: Drive wheel to Moon position indicator (adapted from De Solla Price, 1974).

Greeks were using the **Metonic cycle** or **Enneadecaeteris**¹² (see Appendix), a 19-year calendar that combined the relative moves of the Sun and the Moon. Although nowadays a Moon-based calendar seems pointless, during ancient times the phase of the Moon was crucial for many reasons. While orbiting around the earth, Moon has two different period types: a 27.3 days cycle called **sidereal month** with respect to the background stars and a 29.5 days cycle called **synodic month** (or lunar month) with respect to Earth and Moon's relative positions. Within each Metonic cycle (19 years) the Moon circles the sky for 254 times, which means that every 19 years the Sun and the Moon come back to (almost) the same positions.

All the "combined" gears within the Antikythera mechanism follow a rather simple rule: if the gear "A" has 20 teeth and the attached to it gear "B" has 10, then for each turn of the gear "A" results 2 turns for the gear "B", or with ratio language: 20/10. For Price the task was now to "prove" that the related for the Sun and Moon gears had an overall ratio of 254/19: Sun and Moon's pointers should be at the same position after 19 turns for the Sun and 254 turns for the Moon. There were six gears related to the Metonic cycle and the counts of Dr Karakalos and his wife resulted the following ratio:

$$\frac{65}{38} \times \frac{48}{24} \times \frac{128}{32} = \frac{260}{19} \quad (1)$$

Price was nearly there! By adjusting the tooth-counts within the range of possible errors provided by Dr Karakalos (colored with red), Price took:

$$\frac{65}{38} \times \frac{48}{24} \times \frac{128}{32} = \frac{254}{19} \quad (2)$$

The moment for Price must have been monumental! After nearly twenty years, he had managed to step where no other scholar had before him and unlock the mechanism's secrets. Price also examined the possibility that the ancient maker would had encapsulate another calendar, the 8-year **Octoeteris**¹³ but the needed ratios, gear sizes and number of gear-teeth strongly suggested that this scenario was impossible or at least difficult to be constructed.

As Price finished this challenge he had to deal with an additional one that had to do with the nature of differential gearing: if gear "A" rotates clockwise and is in contact with gear "B", then gear "B" rotates counterclockwise. That was a big problem, since

¹² Meaning literally: 19 years

¹³ A period of eight solar years after which the moon phase occurs on the same day of the year plus one or two days.

the Sun and the Moon had to rotate in the same direction. His insight based on previously gained experience from reconstructing ancient artifacts like the Tower of the Winds and the Chinese water-driven clock, gave him the solution: there must have been another, now lost gear, that was driving the Sun's pointer. This gear should be of the same size as the MDW attached on the same way at the crown wheel.

2. Drive wheel to differential turntable and Differential output to synodic month

1 year = 12 synodic months

1 year = $(12 + 12 \times \frac{1}{12})$ sidereal months = 13 sidereal months

thus :

$$\left[\begin{array}{l} \text{Number of sidereal months} \\ \text{in a time period} \end{array} \right] = \left[\begin{array}{l} \text{Number of synodic months} \\ \text{that have passed} \end{array} \right] + \left[\text{Number of years} \right] \quad (3)$$

or :

$$\left[\begin{array}{l} \text{Number of synodic months} \\ \text{that have passed} \end{array} \right] = \left[\begin{array}{l} \text{Number of sidereal months} \\ \text{in a time period} \end{array} \right] - \left[\text{Number of years} \right] \quad (4)$$

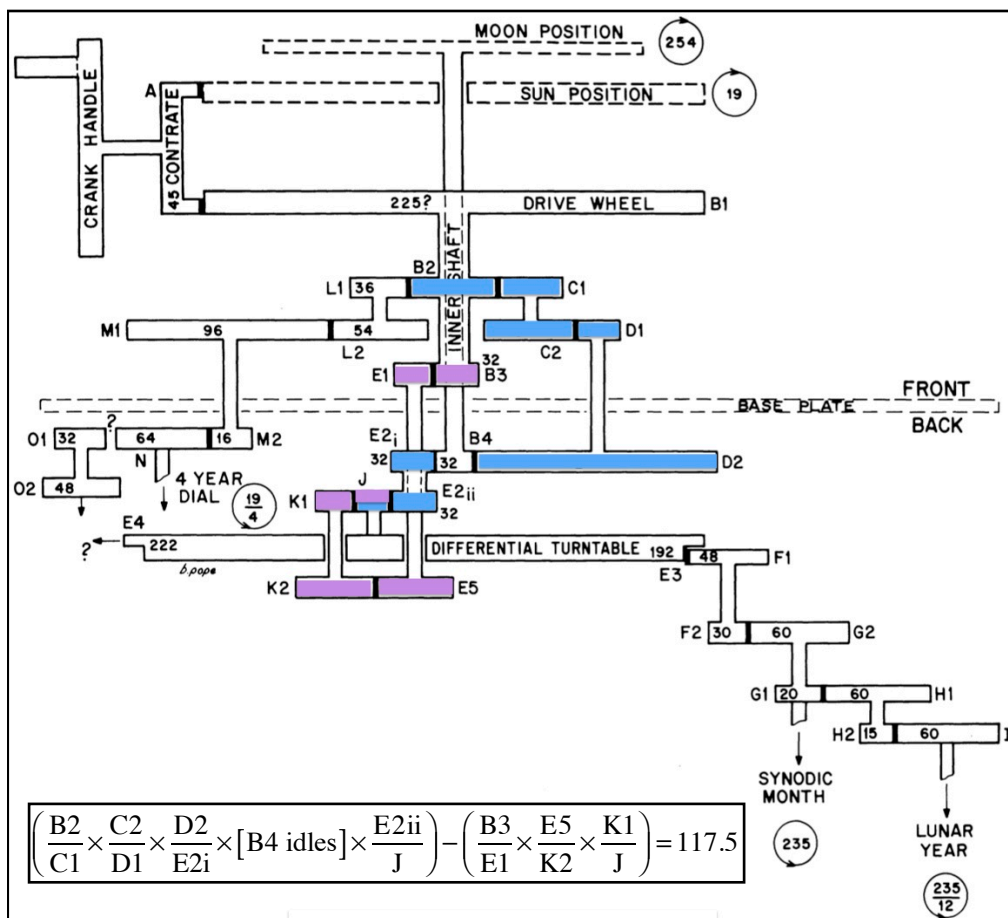

Fig. 20.2: Drive wheel to differential turntable (adapted from De Solla Price, 1974).

Although he finally managed to overcome this difficulty, there was a series of other gears leading to a turntable at the back of the mechanism. Price had to determine the purpose of these gear trains and turntable, associated with the ones at the front that served as an input. Convinced that the ancient maker would surely wanted to depict not only the movement but also the phases of the Moon, he started brainstorming about the possibilities of such an attempt. In every full Moon, the Sun, Earth and Moon are positioned in a straight line, so the Moon phases are directly related with synodic months. Having in mind the relationship between sidereal and synodic month, it takes a synodic month for a full Moon or a sidereal month and a twelfth of a sidereal month for a full Moon to occur. That means that for every year there is an extra synodic month.

The previous gears were parallel, meaning that they could multiply or divide rates of

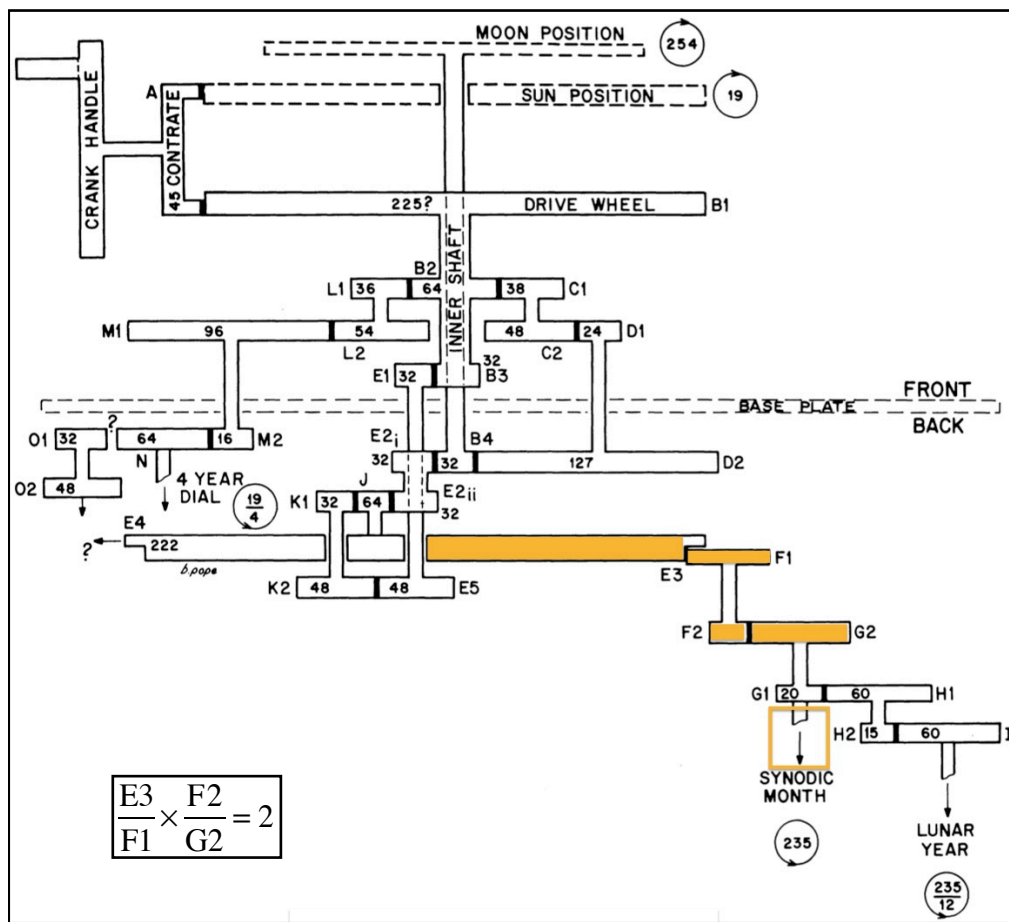

Fig. 20.3: Differential output to synodic month (adapted from De Solla Price, 1974).

rotation. In order to depict the phases of the Moon, the ancient maker should have been able to calculate the number of the synodic months and thus according to the equation (4) there was a need for subtraction. Achieving this would engage another type of gearing: **differential gears**.

Price recognized a set of three small gears attached to a bigger turntable. He concluded that the combined gears had as “input” the speed ratio of the Sun pointer and produced as an “output” the Moon phases based on equation (4). In particular the engaged gears produced the series of of the following ratios for 19 turns:

$$\underbrace{\left(\frac{64}{38} \times \frac{48}{24} \times \frac{127}{32} \times \frac{32}{64}\right)}_{1/2 \text{ sidereal months}} - \underbrace{\left(\frac{32}{32} \times \frac{48}{48} \times \frac{32}{64}\right)}_{1/2 \text{ number of years}} = \left(\frac{127}{19}\right) - \left(\frac{1}{2}\right) = \underbrace{117.5}_{1/2 \text{ synodic months}}$$

The output multiplied by 2 (with another parallel gear) resulted the 235 synodic months of the 19-year Metonic cycle.

3. Drive wheel to four-year dial

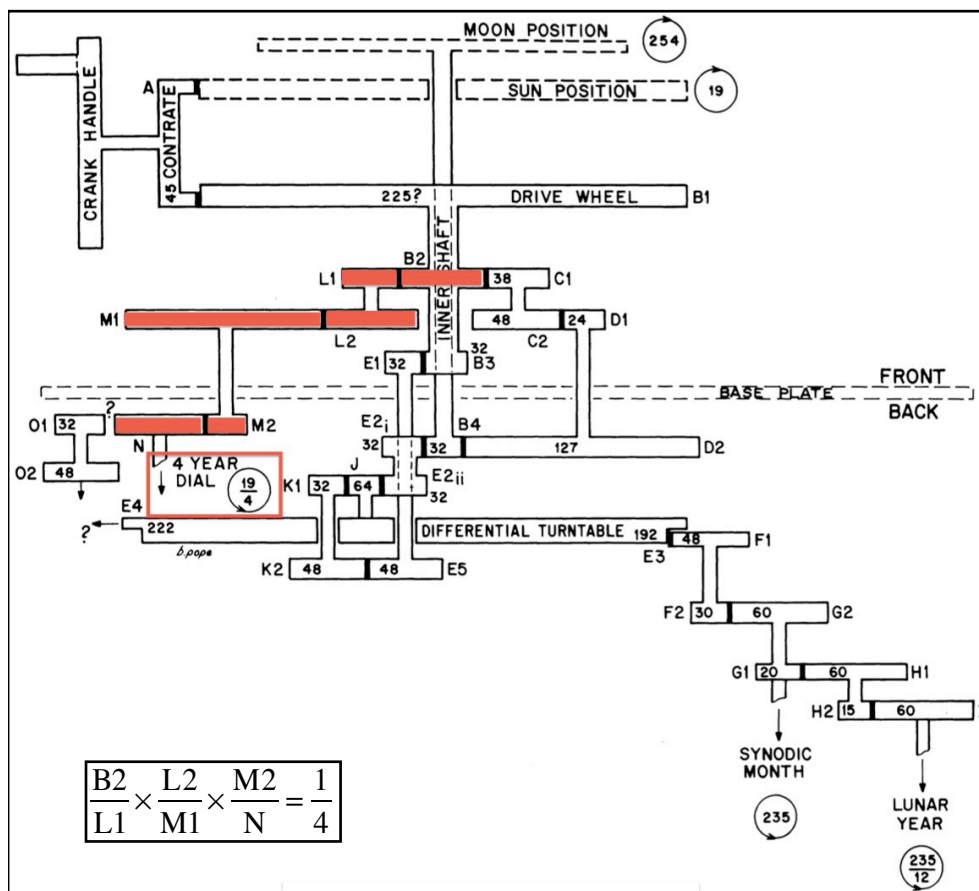

Fig. 20.4: Drive wheel to four-year dial (adapted from De Solla Price, 1974).

The final gear train for Price was the one resembled at the upper back dial. Although he hadn't have much evidence and some gears were standing unassigned by Price's reconstruction, he speculated that it had been showing the months of a 4-year cycle.

After finishing with the gearing, Price focussed on the inscriptions. He firstly noted that the fragments condition despite their delicate treatment, had decayed furthermore and reading the engraved letters was very difficult. Fortunately he was in possession of

photographs resembling the artifact's condition during the last years, provided to him by Dr. Ernst Zinner. Moreover, the fact that the artifact's recent treatment had revealed

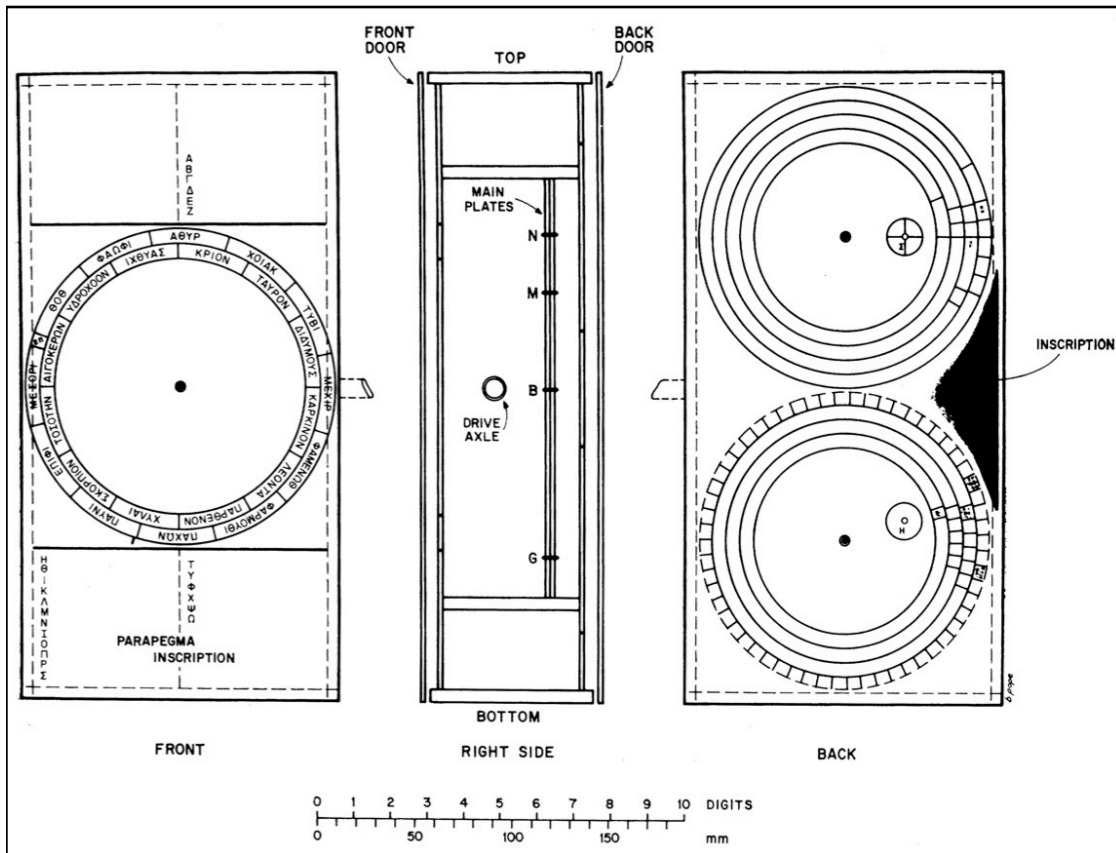

Fig. 22: Price's proposed reconstruction (De Solla Price, 1974)

[K]	. . . evening
[A]	The Hya[des se]t in the evening
M	Taurus [be]gins to rise
[N]	Vega rises in the evening
Ξ	[The Pleiad]es rise in the morning
O	The Hyades rise in the morning
Π	Gemini begins to rise
P	Altair rises in the evening
Σ	Arcturus sets in the [morning]

Fig. 21: Parapegma inscription (De Solla Price, 1974)

more letters previously unreadable and that had he had obtain copies of Albert Rehm's personal unpublished notes, helped him to suggest new words especially from the Parapegma inscription (Fig. 21). The other fragment's inscriptions were in bad condition and Price was considerably unable to purpose a reconstruction.

Price was mainly amazed by the the complexity and the embodied differential gearing knowledge that Antikythera mechanism was carrying: these were only to be appeared centuries later during the Renaissance. In addition he argued that the basic encapsulated knowledge, that is the 19-year cycle, shared links with the East. Although the fall of Greco-Roman civilization had surely swept the technology off, he argued that portions of it was transferred to the Islamic world and managed to survive (De Solla Price, 1974; Marchant, 2010a). Price cited a manuscript written by Abu Rayhan al-Biruni around 1000 AD where the latter

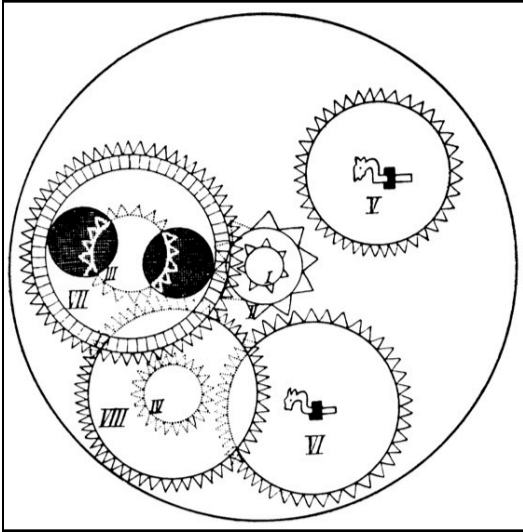

Fig. 23: al-Biruni's "Moon in the Box" (De Solla Price, 1974)

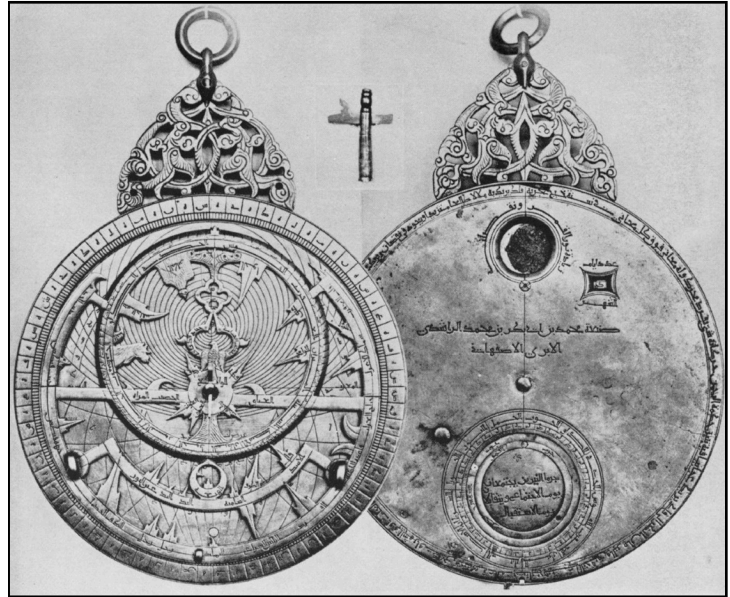

Fig. 24: The Iranian astrolabe, Museum of the History of Science, Oxford (De Solla Price, 1974)

described a geared calendar called "Box for the Moon" (Fig. 23) which could be fixed to the back of an astrolabe.

He also mentioned an Iranian calendar (Fig. 24) similar to al-Biruni's Moon in the Box,



Fig. 25: Derek de Solla Price

made in the early 13th century, by M.b. Abi Bakr Isfahan. Price argued that both astrolabes were direct descendants of the Antikythera mechanism and that this knowledge was later carried to Europe and triggered the sudden bloom of astronomical clocks.

Price's opus "Gears from the Greeks" was more than welcomed and the Antikythera mechanism was credited as the most ancient artifact by scholars but it didn't manage to change conventional views of ancient technology. Von Daniken and Reinl's work "Chariots of the Gods" (Von Daniken & Reinl, 1968) had already put the Antikythera mechanism into the sphere of the occult and mainstream historians were unwilling into taking seriously account the artifact (Marchant, 2010a).

This was the last attempt of Price to decipher this enigmatic relic; he felt that there was nothing more to say or add (Marchant, 2010a). Derek de Solla Price died suddenly in September of 1983 while visiting in London his friend, editor of the Discovery magazine Antony Michaelis.

4. Modern Times (1990 - 2012)

Price's work although inaccurate or at least incomplete, had revived the interest on the enigmatic artifact. A new generation of engaged scholars carried research on: their work influenced and finally changed our understanding of the Antikythera mechanism. Although Price was the first who sought technology methods for unlocking the secrets of the Antikythera mechanism, this period distinguish from the other once since more advanced methods were applied and the scholars tended to seek collaboration. As before, the presence of leading figures in related research marks and defines the structure of our work. For this period we distinguish the works of Michael Wright, Tony Freeth, Mike Edmunds, Alexander Jones and James Evans to name a few.

4.1 A Solitary Craftsman

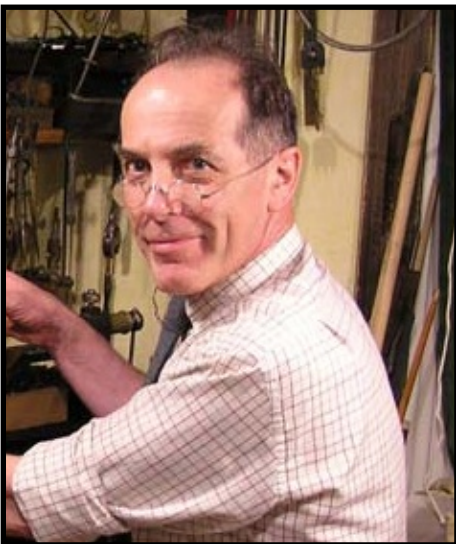

Fig. 26: Michael Wright

Michael Wright was familiar with Price's work "Gear from the Greeks" since its first publication in 1974. He was aged 26 back then, and was holding a curator's position at the Science Museum in London. Although Wright was initially impressed by Price's work, the more he studied the article, the more certain details worried him (Marchant, 2010a). More over, his engagement with the reconstruction of the famous geared Byzantine clock (Fig. 27), the second-oldest geared mechanism, had prompted him to reconsider the model from "Gear of the Greeks" (M. T. Wright & A. G. Bromley, 2001). In particular (Marchant, 2010a; Wright, 2005a):



Fig. 27: Wright's reconstruction of the Byzantine clock.

1. Price had changed the teeth numbers, despite Dr. Karakalos estimations, in favor of his model.
2. There was an easier way of depicting the phases of the Moon by using simple gearing. A complicated differential gearing for that reason seemed less possible.
3. Price's recommended reconstruction of the back dials was too simple compared with his proposed model for the front dial.
4. Since the ancient maker had decided to place the "Main Drive Wheel", a huge gear in comparison with the other ones, there must have been a more sophisticated reason than simply transferring its



Fig. 28: Allan Bromley (wikipedia.org)

motion to a smaller gear.

In 1983 Wright started planning his future moves in order to decipher the ancient mystery which included a visit to Athens for closely examining the artifact but the Museum's director rejected his request for research time. His connection with Allan Bromley in order to assist him reconstructing a solid model of Charles Babbage's computing machine, gave him the opportunity to join him as an assistant to Bromley's research project for the Antikythera mechanism in 1989. Although Wright was the one that exposed Bromley in the ancient artifact, Bromley acted egoistically and his plans were to solve the Antikythera's mystery on his own by leaving Wright outside (Marchant, 2010a). Bromley published a series of articles but they were only attempts to partially

reconstruct Price's model (Bromley, 1986, 1990). This stance of his, characterised the relationship between the two men that left a bitter taste to Wright, who was feeling betrayed till Bromley's death in 2002.

Wright and Bromley had the opportunity of closely studying the mechanism and a new fragment discovered in 1976, fragment E, during the winter of 1989. Their first impression was that Price had missed several important details and had been mistaken in several important aspects such as the accuracy of the scheme for the fragments' joints and the placement of several gears. After taking notes, photographs and new radiographs, the team headed back to London. During a lecture that Bromley gave at the Antiquarian Horological Society, Alan Partridge, a retired doctor, purposed the building of a simple linear tomography machine for further examination of the Antikythera Mechanism (Marchant, 2010a). Wright, a well skilled craftsman, built the necessary equipment and merged it with the X-ray source at the Athens museum where he took new and high quality radiographs at their next visit with Bromley in 1990: after three years in early 1994, over 700 radiographs had been taken by Wright. When he finished Bromley (following his plans), left for Sydney taking all the radiographs with him, leaving an astonished and betrayed Wright behind.

During the following years, Wright was dealing with certain difficulties (in personal and professional level) and faced the horrible face of depression. Despite his condition, he kept thinking on Price's model: he could recall a wheel at the end of the Metonic train gear that Price had missed. This wheel had the same number of teeth but opposite rotational direction. This observation made clear that the result of the train gear fed it in the differential gearing would had as a result adding the rotations of the Sun and the

Moon, a pointless action (M. T. Wright & A. G. Bromley, 2001). But without the radiographs his efforts were inadequate. Then in 2000, Bromley contacted with Wright revealing him his health condition: doctors were giving him up to six months to live. Wright visited Bromley and the latter gave him most of the radiographs: this was the last time that the two men saw each other.

When Wright returned to London, he started working with the radiographs trying to support the ideas that all this time were puzzling him, in the presence of evidence. He started publishing his findings in 2001 and although Bromley was not conducting research during this time, he cited him as a coauthor (M. T. Wright & A. Bromley, 2001): a sample of Wright's superiority and fair-play.

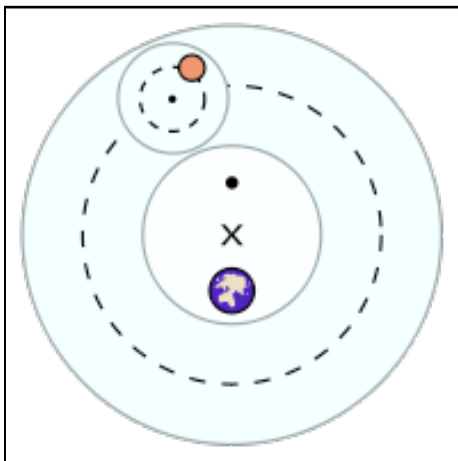

Fig. 29: The epicycle concept (wikipedia.org)

One of Wright's earliest ideas was the possibility that the front of the mechanism had more gears, lost now, that were responsible for depicting the movement of the planets. This approach could not only extend the mechanism's functions but also explain some enigmatic features that Price had missed or omitted (M. T. Wright & A. G. Bromley, 2001). The first problem that Wright had to deal with was the determination of the planetary system that the Antikythera mechanism was modelling. In agreement with the mechanism's dating context, Wright considered Hipparchus's solar and lunar theory as a promising candidate. The Greeks were convinced that

celestial object should follow circular orbits in a uniform manner: the planet's observed erratic movements in the sky upset the Greeks and they rushed to establish a theory that would explain these anomalies. The solution came in the form of **epicycles** and **eccentric models**: planets were traveling in a small circle, while the centre of this circle was moving around the Earth or with a circular orbit but with a slightly offset centre. This concept could explain why planets appeared to speed up, slow down or even going backwards from time to time. Although Hipparchus's theory could be applied to the Moon and Sun's movements, adopting Ptolemy's epicycles for the planets (established 200 years later) could be seen as an anachronism but could offer a further rationale (M. T. Wright & A. G. Bromley, 2001).

Wright presented his bold ideas during 2001 at a conference in Olympia, Greece (Wright, 2003a) but his suggestions were received rather skeptically: the concept of adding extra gears with no remained traces to support this, was likely to be controversial (Marchant, 2010a). Wright knew that he was right, so in order to support his view he decided to built a solid model by using methods that his ancients fellows



Fig. 30: Tony Freeth
(antikythera-mechanism.gr)

would have used. He managed to reconstruct the front dial with the gears that were calculating the motions of the Sun and Moon and the epicycles for Venus and Mercury by the end of 2001. Wright had now to construct the epicycles for Mars, Saturn and Jupiter when he learned that he wasn't alone: Tony Freeth, a mathematician and film maker was also working on the subject. Freeth was cooperating with Mike Edmunds, an astronomer from Cardiff University and a team of reputable Greek scientists, who had named their team as "The Antikythera Mechanism Research Project" (AMRP).

Wright had spoken to Edmunds before 2001 when the latter asked him information about the Antikythera mechanism. During a lengthy conversation, Wright told him everything he had managed to decipher so far and his future plans for research. When Edmunds and his research student Philip Morgan published an article about the mechanism (Edmunds & Morgan, 2000), Wright was astonished by the absence of new evidence: they were just reviewing Price's work (Marchant, 2010a). Moreover the only worthy points made by Edmunds and Morgan were the ideas that Wright had shared with Edmunds: at the end of the article Wright was just acknowledged for a "communication". Wright once more felt betrayed (Marchant, 2010a). Later he wrote (Wright, 2002):

"Last year I saw an article showing that others were thinking along similar lines, but in my notes I already had an arrangement that was more complete and workable, as well as being more closely founded in evidence, and I immediately described it in a conference paper".

Finally after rejecting an offer from Freeth to join their campaign, Wright published the planetary display of his reconstruction in May 2002 (Wright, 2002). Wright placed seven pointers around the zodiac ring, one for the Sun and Moon and five for the known planets: Mercury, Venus, Mars, Saturn, Jupiter (Fig. 32). Wright based a great part of



Fig. 31: Mike Edmunds
(astro.cardiff.ac.uk)

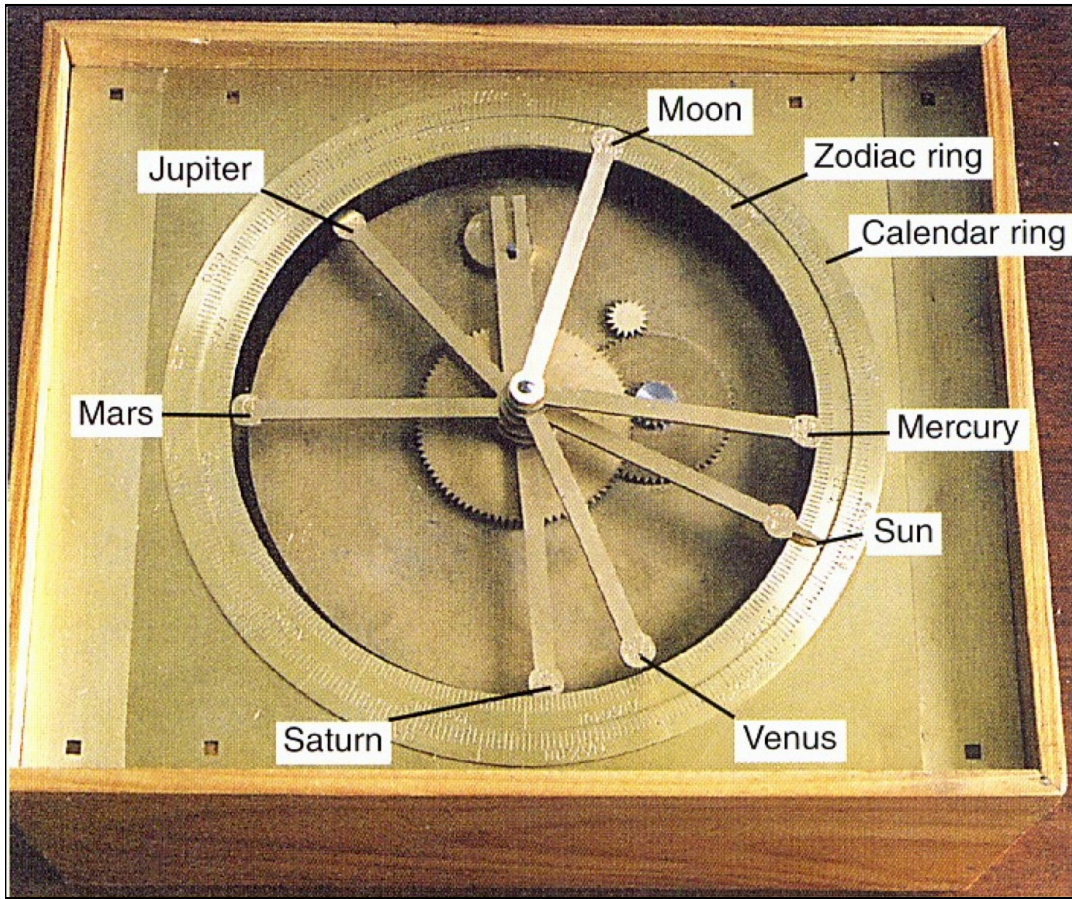

Fig. 32: Pointers at the front dial
(Wright, 2002)

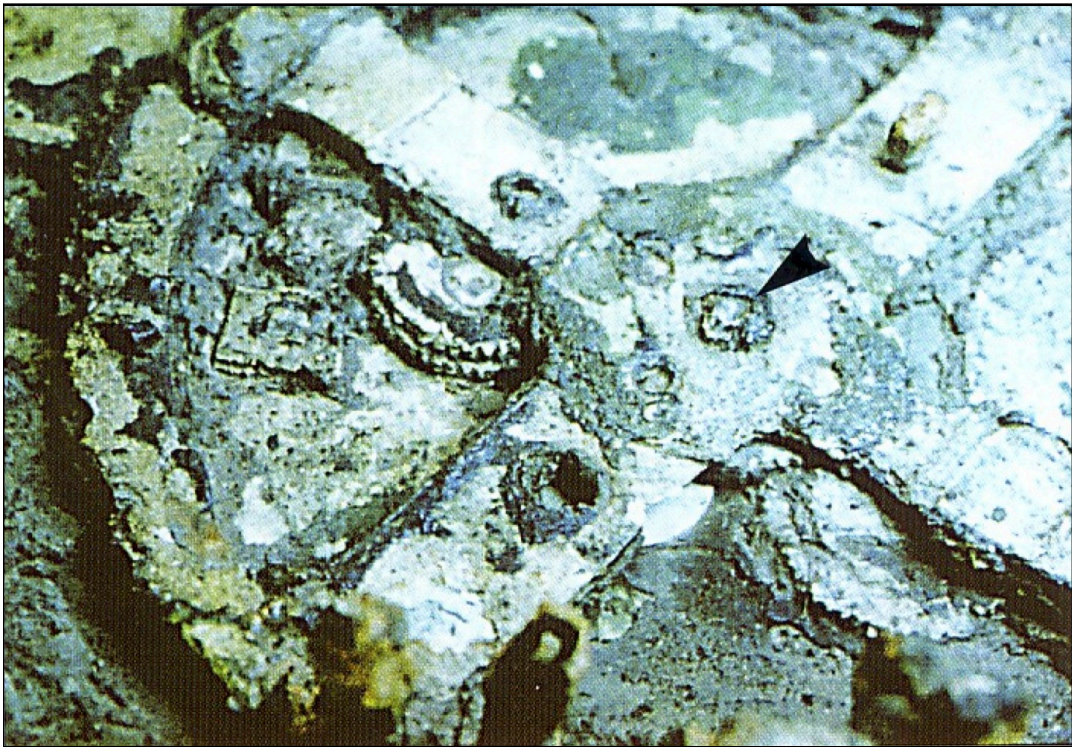

Fig. 33: A close-up of the fragment A, showing the square pipe (arrow)
(Wright, 2002)

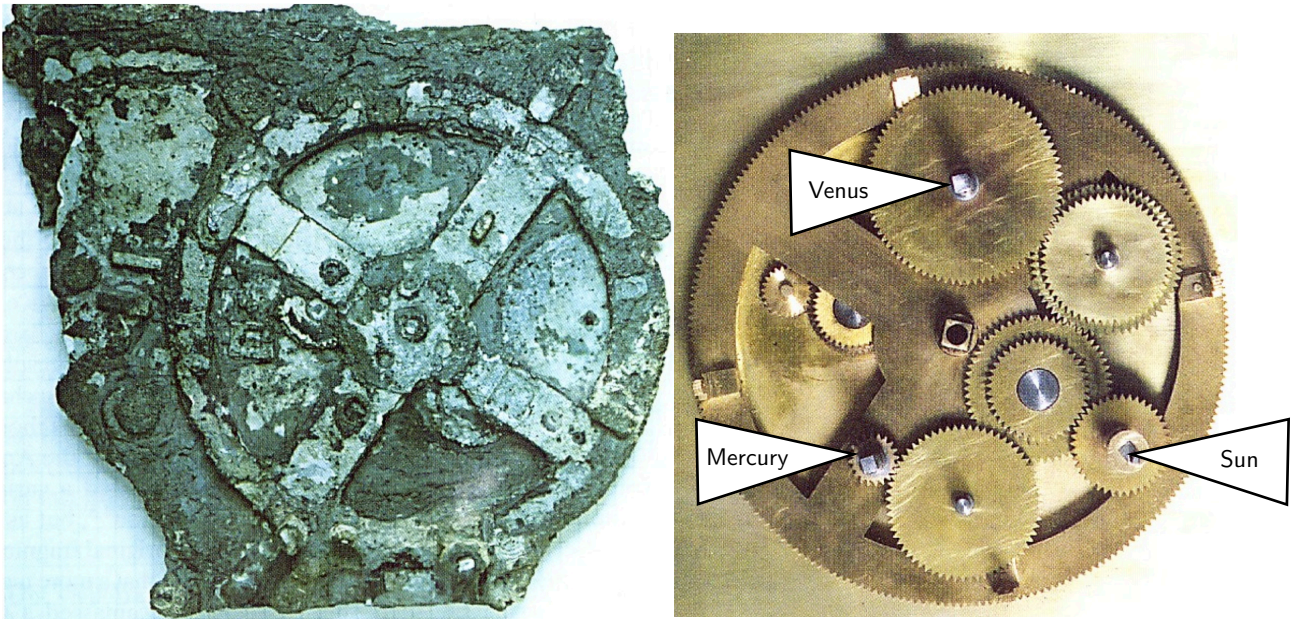

Fig. 34: A comparison of fragment A with the epicyclic train on the Mean Sun Wheel. (adapted from Wright, 2002)

his reconstruction on a squared knob, like an hour-hand pipe placed on the “Mean Sun Wheel” which Price had previously named it Main Drive Wheel (Fig. 33). Wright proposed that some components was carried on: that component should be a lost now epicyclic gear. He also noted that Hipparchus’s solar and lunar theory could be modelled with a simple epicyclic arrangement by placing turntables for each celestial object (Fig 35). Wright’s reconstruction didn’t raise any difficulties during the placement of the gears, a fact that was at least showing that the embodied model was right. Again he

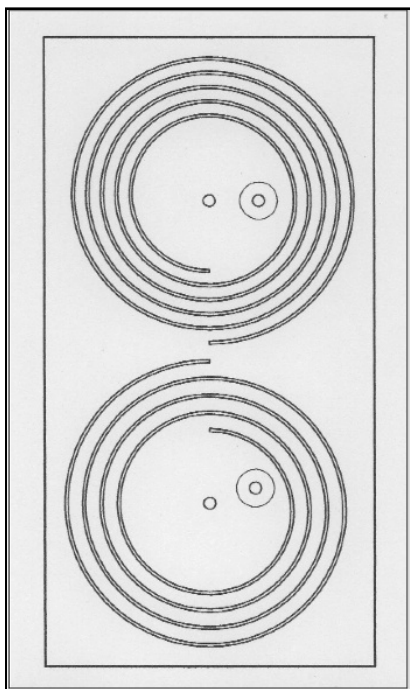

Fig. 35: Wright’s diagram of the spirals (Wright, 2003b)

argued that the mechanism’s overall complexity was suggesting a front dial with more features than the one proposed by Price.

In early 2003 Michael Wright was discharged from his duties at the Science Museum and Bromley’s wife sent him the remaining radiographs. After digitizing the radiographs, Wright was able in working on them with a few clicks at his personal computer. Wright was trying now to focus on the back dials. By measuring the dials on the back, he immediately realized a strange pattern: although the rings were concentric, two halves of each dial were drawn around a different centre forming a single spiral for upper and lower dial (Wright, 2003b, 2005b). In particular the upper dial had 5 turns and the lower dial 4 turns, dissected into 235 divisions resembling the months of the Metonic cycle, calculated by the gear train at the front dial. The two spirals were probably arranged in a

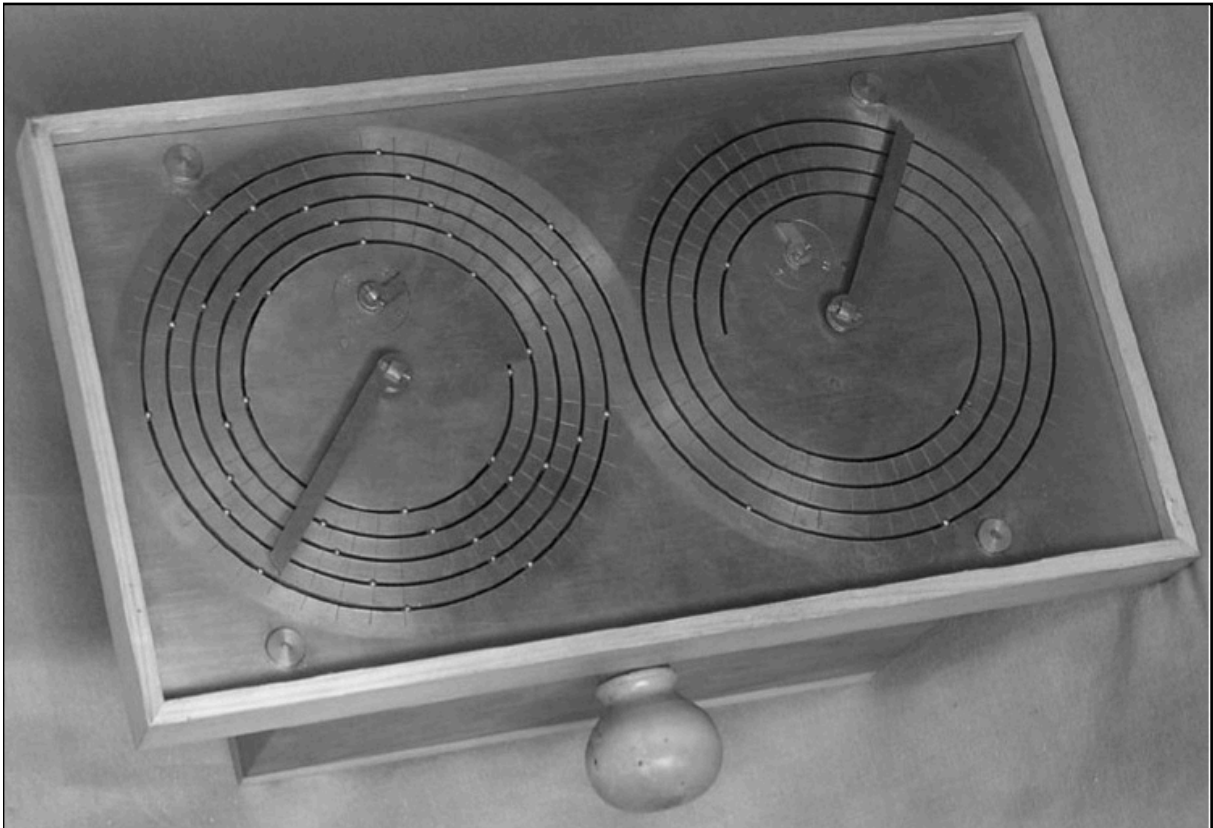

Fig. 36: Wright's reconstruction for the back dials (Wright, 2005b)



Fig. 37: Wright's reconstruction for the Moon phase display (Wright, 2006a)

continuous S shaped spiral and each of the 235 divisions had probably engraved characters (Fig. 36). He also place a series of movable beads that were probably used as markers for dates around the spirals. Additionally, Wright spotted that the smaller dials which were placed near the centre of each spiral were divided into four segments. These dials had also engraved letters only partially readable (letters A, H, Δ and IB). He concluded that one of the smaller dials was modeling the **Callippic cycle** (see

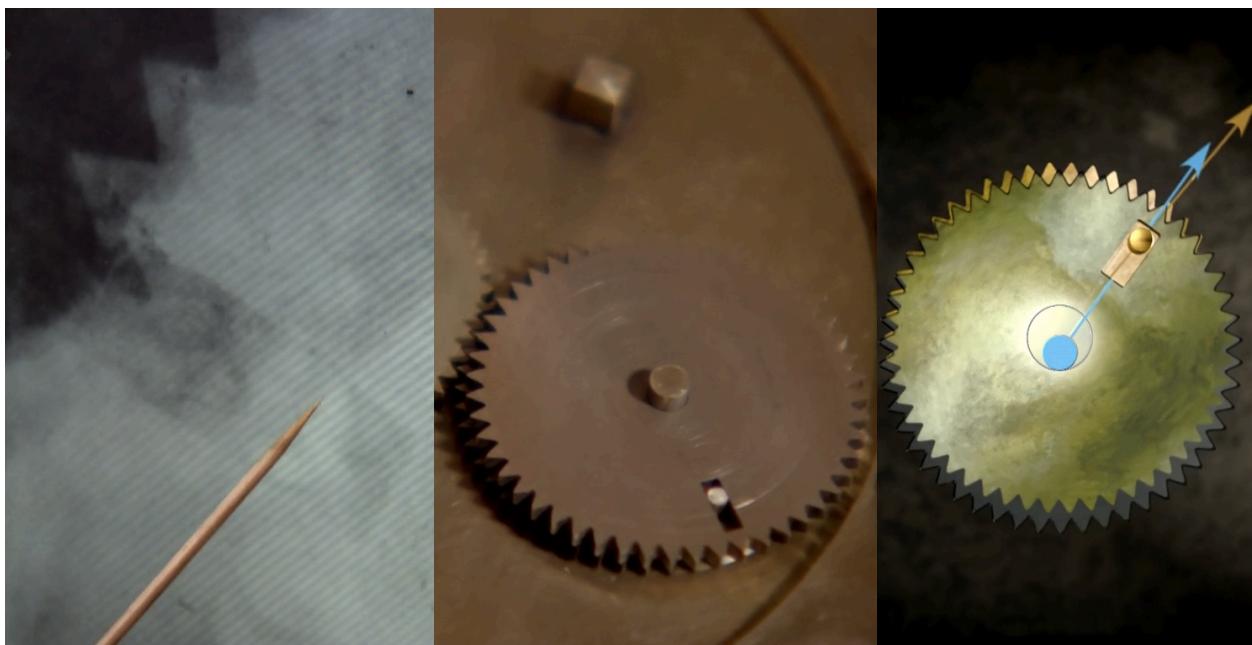

Fig. 38: The pin-and-slot mechanism: Wright's radiograph (left), Wright's reconstruction (middle), simulation model (right) (adapted from Beckham, 2012)

Appendix). Wright's thought for the Callippic cycle was based on readable inscriptions near the small dials and although the needed gears were missing, by adding three extra wheels the simple gear train was working successfully.

Wright also examined a strange circular arrangement on the front dial: although it seemed to be the remains of a crank handle, his experience with a later astronomical clock, suggested him that it was a Moon phase display (Fig. 37).

Wright now was almost near to make his biggest discovery: the pin-and-slot mechanism, a gear scheme that was used in later astronomical clocks for depicting the varying speed of the planets, a result of their elliptical orbits.

For the time Wright wasn't aware of the the slot and pin's purpose: Tony Freeth would later say that this discovery was the most brilliant one since the discovery of the mechanism itself but Wright had just missed the significance of it. Wright himself firstly thought that it was some kind of mechanical fossil (Beckham, 2012). Despite the fact that Wright had missed it for the moment, the pin-and-slot mechanism would provide him great support for his ideas on the epicyclic gearing for the motions of the Sun, Moon and planets (Marchant, 2010a). Wright also noticed a rather strange number of gear teeth: 223, a prime number. For Wright the implementation of a prime big prime number within the gearing was odd and without any purpose.

Finally Wright had to deal with some puzzling findings about the lower back spiral suggesting the existence of **draconic months** (see Appendix) but he didn't have much time. He was aware of Freeth and Edmund's team progress and despite his previous enigmatic findings he rushed to built the model and the proposed gear scheme and

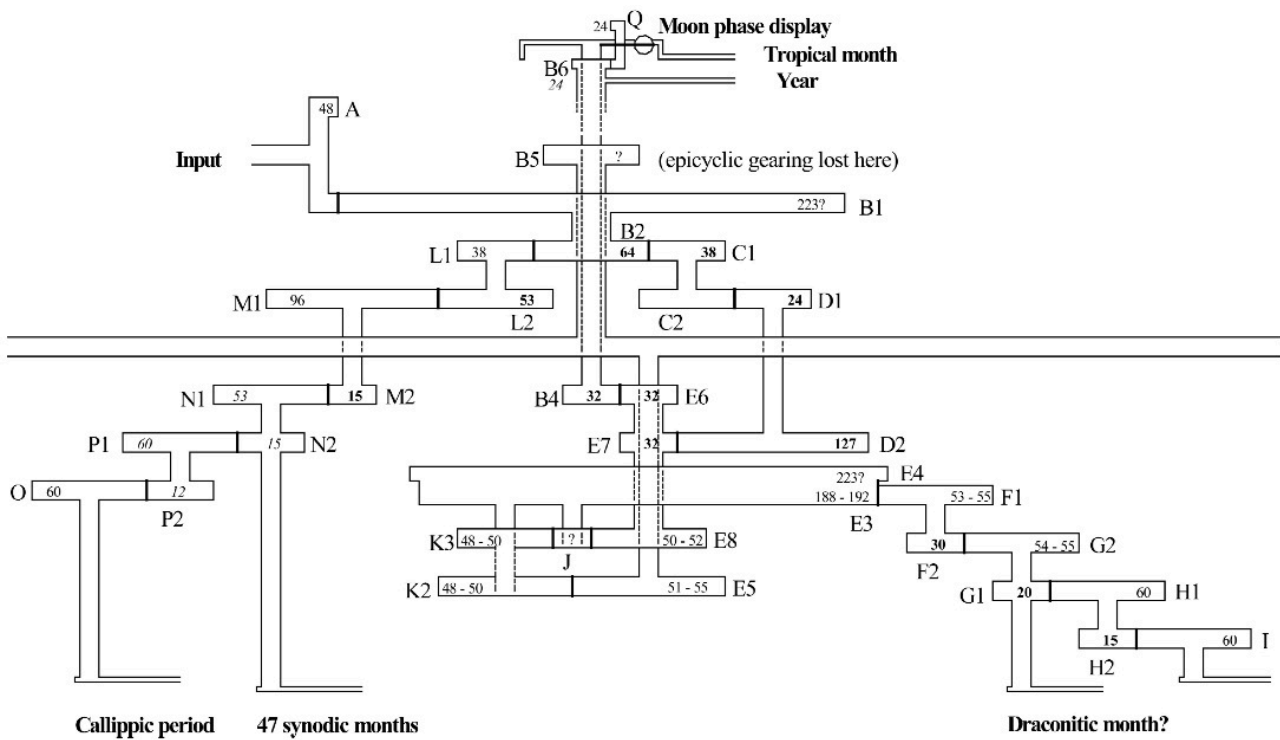

Fig.39: Wright's proposed gearing scheme (Wright, 2005a). Compare with Price's scheme at Fig. 20.1.

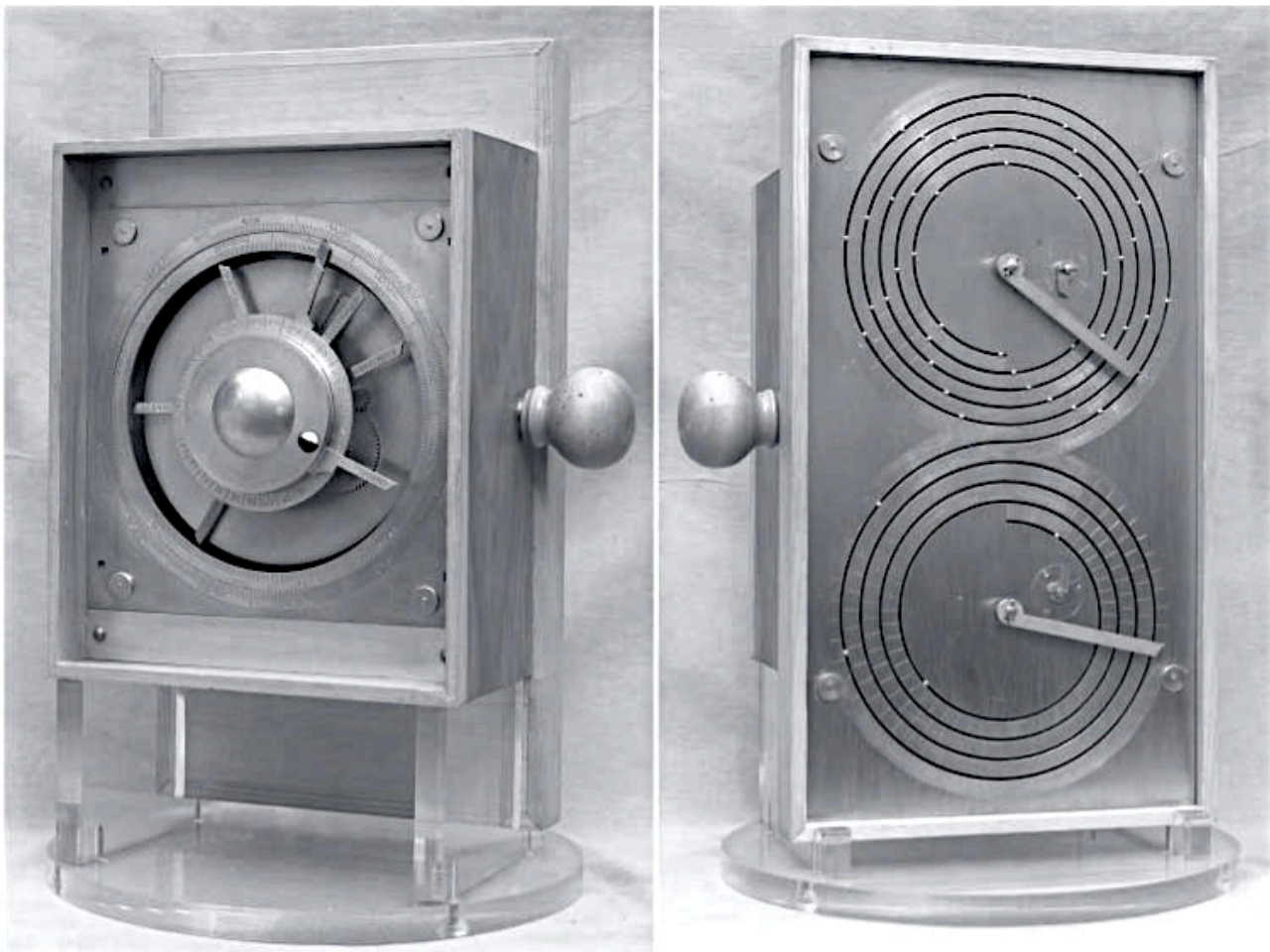

Fig.40 : Wright's reconstructed working model, front and back (Wright, 2007)

claim the solution for his own (Marchant, 2010a). He presented his findings at the 2nd National Conference for Ancient Greek Astronomy in Athens. After working feverishly with almost 700 radiographs during the last four years, his newest conclusions were the following (Wright, 2006b):

- ▶ His reconstruction, unlike all earlier ones accounts nearly all the mechanical details observed in the fragments. Additionally his robust workable model illustrates the correctness of his scheme.
- ▶ Price had overlooked evidence showing the presence of epicyclic gearing.
- ▶ The Sun and Moon's movements follow Hipparchus theory while the five known planets move accordingly the simple epicyclic theory suggested by Apollonius.
- ▶ The Antikythera mechanism was probably a planetarium.
- ▶ The proposed gear scheme corresponds to the original arrangement of the wheels, whereas Price's scheme does not.
- ▶ The pin-and-slot mechanism and the 223-tooth gear must have been spare parts recycled from other devices.
- ▶ The lower back spiral had shown a period of four draconic months, split into 218 half days.

It's October of 2005 and Wright's presentation was the conference's highlight: a new team having its roots back to 1998 is now about to lead research into unknown paths.

4.2 Technology Boost

Seven years before Wright's triumphant presentation, Mike Edmunds was searching for a project for one of his students when he came across with Price's opus and contacted with Michael Wright. He also described the Antikythera mechanism to an old friend of his, Tony Freeth, and suggested that it would make an excellent subject for a documentary. Freeth, a freelance film maker, instantly thought of the mechanism as an icon of the ancient world but after reviewing Price's work in depth, he was convinced that there was a lot more to be said on the subject and changed his primary plans: he would be the man to solve this 2,000 years old mystery.

Freeth's primary concern was that the mechanism's condition demanded more drastic approaches and techniques than the ones previously applied by other researchers. He was firstly prompted that a new technique was available, ideal for the Antikythera mechanism: it was called "microfocus X-ray imaging" and developed by X-Tek Industrial. This technique would eventually produce the most accurate 2-D and 3-D radiographs since Price's era. Freeth also came in contact with a researcher from California working at Hewlett-Packard, who had developed a photographic technique for making readable old and not well preserved artifacts by omitting light from many directions.



Fig.41: From left to right: John Seiradakis, Xenophon Moussas, Agamemnon Tselikas and Yanis Bitsakis.

Freeth had now to deal with two major problems: finding funding for the project and assuring permission from the National Archaeological Museum at Athens to study the fragments. Mike Edmunds applied for grant money from the Leverhulme Trust and finally got funding in early 2005 but the most challenging part appeared to be getting permission. Freeth gradually formed a team by recruiting distinguished Greek scholars in order to influence the Museum's stance: John Seiradakis, radio-astronomer at the University of Thessaloniki, Xenophon Moussas, astrophysicist at the University of Athens and Agamemnon Tselikas, director of the Centre for History and Paleography in Athens.

Despite the presence of prestigious Greek scholars the Museum's answer was no: Xenophon Moussas finally arranged an appointment with the Deputy Culture Minister Petros Tatoulis who granted the team's access to the Antikythera mechanism in September 2005. After dealing with technical difficulties and transferring the X-ray apparatus from United Kingdom to Greece, the AMRP team started to work with the enigmatic relic in October 2005: they eventually produced a mass amount of data (more than one terabyte) including digital photographs, surface PTM¹⁴ imaging and X-rays (2-D and 3-D). During their visit in Athens, a member of staff at the National Museum called Mairi Zafeiropoulou, discovered a new fragment, which she called it fragment F. When the data were ready, Freeth hired a Greek physicist, Yanis Bitsakis in order to apply his technical expertise of reading ancient and medieval texts.

The team started working immediately with Tselikas and Bitsakis trying to read the engraved characters from the enhanced images. Their most significant findings and conclusions were (T Freeth et al., 2006; Tony Freeth et al., 2006; Marchant, 2010a):

- ▶ The word "**ΕΛΙΚΙ**" meaning spiral. This word was found among the phrase: "the spiral divided into 235 sections". This was not only the first evidence that the device did

¹⁴ Polynomial Texture Mapping



Fig.42: A demonstration of how PTM technology can change our perception of the photographs.

Left column: initial pictures, Right column: adjusted pictures.

(http://www.hpl.hp.com/research/ptm/antikythera_mechanism/)

include operating instructions but also confirmed Wright's measurements, suggestion of spirals instead of concentric circles and the presence of 235 synodic months and the Callippic cycle.

- ▶ The word "**ΣΤΗΡΙΓΜΟΣ**" meaning stationary point: a stationary point is a fictional point where a planet's apparent motion changes direction.
- ▶ They confirmed the zodiac scale at the front of the mechanism and found the sign of Scorpio.
- ▶ At the front door words referring to Venus and Mercury were found confirming Price. In addition there were some numbers indicating distances between the planets and the Sun.
- ▶ The back of the mechanism contained a long list of operating instructions and mechanical terms mixed with astronomical references: "**ΣΤΗΜΑΤΙΑ**" (trunnions), "**ΓΝΩΜΟΝ**" (gnomon), "**ΤΡΗΜΑΤΩΝ**" (perforations). Also there were found the numbers 19 and 76 corresponding the Metonic and Callippic cycle, respectively.

- ▶ The words “**ΣΦΑΙΡΙΟΝ**” (little sphere) and “**ΧΡΥΣΟΤΝ ΣΦΑΙΡΙΟΝ**” (golden little sphere), probably referring to the Moon and Sun pointers on the zodiac display.
- ▶ The word “**ΙΣΠΑΝΙΑΣ**” (Spain), the earliest known mention of Spain as a country, and other geographical references like “from the South”, “towards the East” and “West-North-West”.
- ▶ The little dial next to the lower back dial was divided into three sections, with only the two of them having numbers: 8 and 16.
- ▶ The wheel of fragment D had engraved the letters “**ΜΕ**” suggesting the short form of the word “*μέσον*” (middle), the number 45 or even the maker’s initials.
- ▶ They identified 16 blocks of characters (Freeth named them “glyphs”) at the lower back dial. Some blocks were containing the letter **Σ** (for the Moon, ΣΕΛΗΝΗ), others the letter **Η** (for the Sun, ΗΛΙΟΣ) and others both. Moreover, the combined letters **Ω** and **Ρ** meaning hour, were forming a glyph that had the shape of an anchor.

Bitsakis and Tselikas raised the amount of deciphered characters to over 2,000 corresponding to the 10% of the overall lettering. The presence of instructions prompted Tselikas that the artifact was not constructed for an astronomer to be used as a scientific instrument but for a wealthy non-specialist owner as a luxury item.

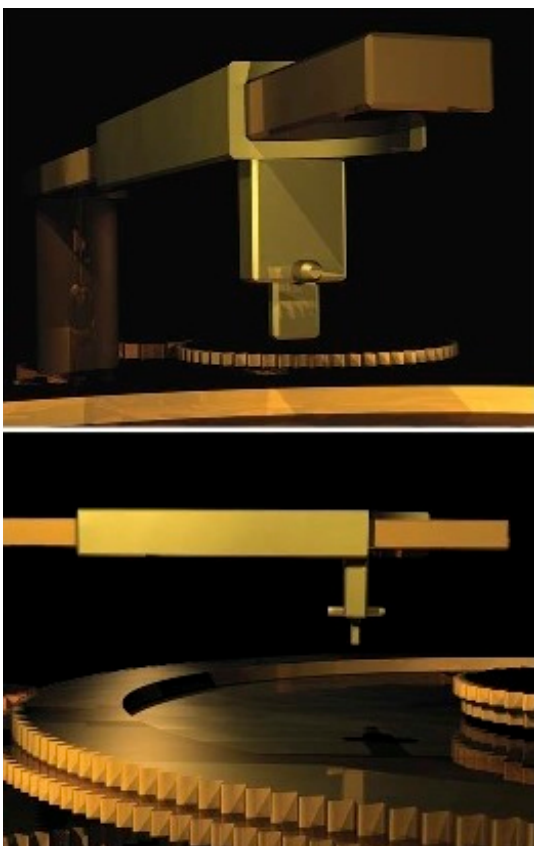

Fig.43: A computer reconstruction of the “pointer-follower” device (Tony Freeth et al., 2006)

In the meantime, Freeth had started counting the gear’s teeth but instead of relying to his eyes, he employed computer software in order to produce a more accurate numbering. Soon he had confirmed Wright’s reading for the gear train that drove the Sun and Moon pointers, the Moon-phase indicator and the train for the Callippic cycle. Then he discovered a new impressive feature: instead of finding the marker beads suggested by Wright he found the remains of a “pointer-follower” device: an extendable arm with a movable pin at the end that was able to “travel” around the spiral groove (Tony Freeth et al., 2006). This feature was explaining why the back dials were designed as spirals and not concentric circles. Freeth now focused on the lower section of the back dial but unlike Wright he had an additional fragment, fragment F, a fair enough big part of the lower dial. Wright’s estimation was 218 divisions but Freeth made a more confident count: 223.

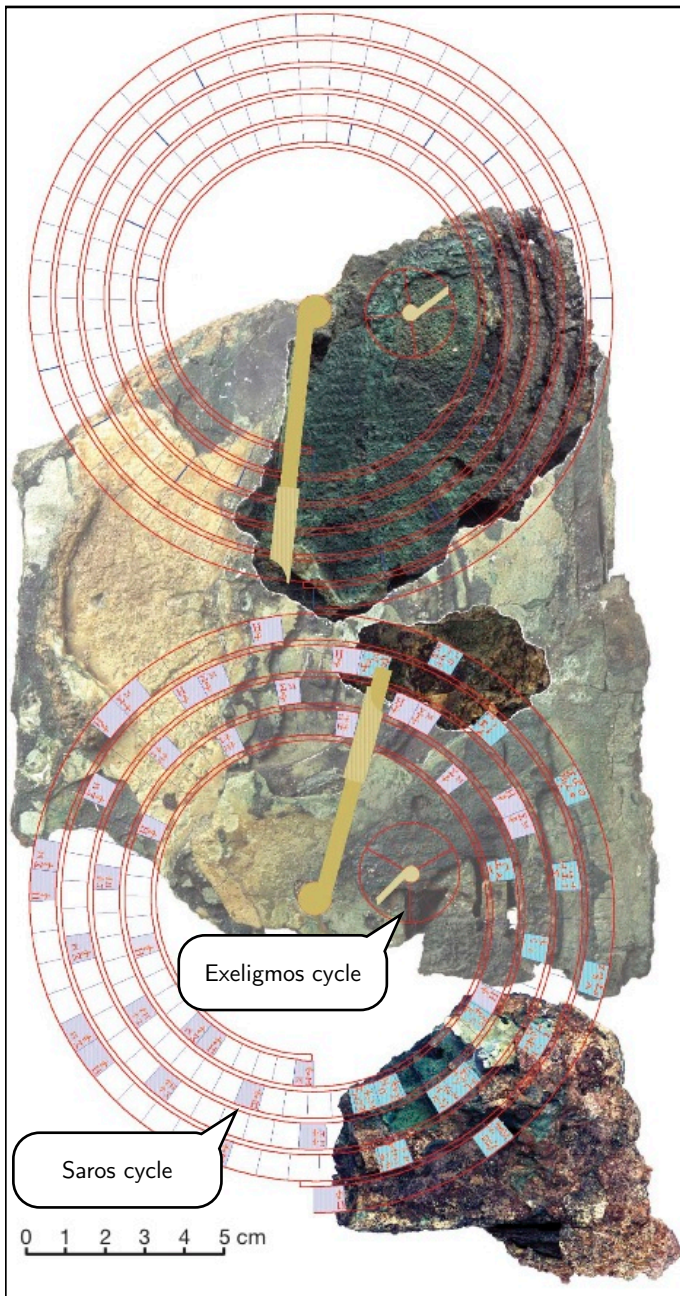

Fig.44: Reconstruction of the back dials, depicting the lower dial with the Saros cycle and Exeligmos cycle (adapted from Tony Freeth et al., 2006)

All the findings so far were suggesting that the lower back dial followed a design for a specific purpose: to predict eclipses based on the **Saros cycle** (see Appendix), a 223-synodic month period. This could also explain the existence of the subsidiary dial which was divided into three sections: for every Saros cycle the main stylus would be reseted by hand while the subsidiary pointer would automatically move to the next third, representing the next phase of the **Exeligmos cycle** (see Appendix). The Exeligmos subsidiary had engraved the numbers 8 and 16 while the third division was empty: it was resembling the hours needed to be added for every phase of the Exeligmos cycle, that is none, eight or sixteen hours (see Appendix).

Then, there was the enigmatic gear with a prime teeth number, 223. For Wright this was an extraordinary feature and under the pressure of the conference in Athens he wiped out the result but Freeth's first thought was that the maker should have a reason for embedding such a large prime number. And the Saros cycle couldn't be a coincidence: this wheel must have been driving the pointer of the Saros dial. By studying the 3-D dimensional

X-rays Freeth proved that there were gears used to model the varying motion of the Moon as Wright had partially predicted but he had no evidence for the other known planets so he restrict his findings to the motions of the Moon and Sun.

The team published its findings on 29 November 2006 and Freeth set a conference to take place in Athens at the same date in order to share their stunning findings: Michael Wright was also invited to participate. Over 500 people came to the open session and when Freeth finished his speech the ovation seemed endless (Marchant, 2010a). Wright



Fig.45: Alexander Jones
(antikythera-mechanism.gr)

was devastated. Despite the work of so many lonely years, recognition was afforded to Freeth and his team. At a later talk during the conference he outlined his work and noted that his radiographs had revealed Freeth's findings years before (Marchant, 2010a). Wright had already submitted an article on 2 September 2006 and he released a note added on 29 November 2006 (Wright, 2007). There he commented that fragment F was not available to him and that the AMRP team actually offered a modification of his gear train in the light of new evidence. He finally added that although the team's findings are significant the changes to his model are physically slight and that he remains to his conclusions presented at the article.

After the AMRP team published the 2006 Nature article, Tony Freeth called another expert to join the team: professor Alexander Jones, an expert on the history of ancient astronomy, from the Institute for the Study of the Ancient World in New York. Jones with Bitsakis and Freeth worked on deciphering the engraved letters of the the Callippic cycle (upper back dial spiral) and the two subsidiary dials. Their readings enhanced by technology offered them additional breaking results (Freeth, Jones, Steele, & Bitsakis, 2008):

1. The back upper dial (Metonic dial) has engraved the names of Corinthian months: "**ΦΟΙΝΙΚΑΙΟΣ**", "**ΚΡΑΝΕΙΟΣ**", "**ΛΑΝΟΤΡΟΠΙΟΣ**", "**ΜΑΧΑΝΕΥΣ**", "**ΔΩΔΕΚΑΤΕΥΣ**", "**ΕΥΚΛΕΙΟΣ**", "**ΑΡΤΕΜΙΣΙΟΣ**", "**ΨΥΔΡΕΥΣ**", "**ΓΑΜΕΙΛΙΟΣ**", "**ΑΓΡΙΑΝΙΟΣ**", "**ΠΑΝΑΜΟΣ**" and "**ΑΠΕΛΛΑΙΟΣ**". These months belong to the Dorian family of months and are directly related with the Corinthian colonies. Seven of the Mechanism's months, however, coincide in both name and sequence with the calendar of Tauromenion in Sicily suggesting a mechanical tradition going back to Archimedes who invented a planetarium described by Cicero. The months are repeated round the dial, a fact that helped the team to decipher them. The recognized numbers show which months should have 29 or 30 days and which year should contain 12 or 13 months, following the rules suggested by the astronomer Geminus (Γεμῖνος ὁ Ῥόδιος) who worked on Rhodes in the first century BC. In addition, the previously generally accepted theory that the Metonic cycle was used only from astronomers was reconsidered since the presence of the months' names on the Metonic cycle was suggesting the adoption by common civil calendars.
2. Within the Metonic dial there are two subsidiary dials. The right one was previously thought to be the Callippic dial (Wright, 2005b) but is not. It is an Olympiad dial, representing the 4 major games of "**ΙΣΘΜΙΑ**", "**ΟΛΥΜΠΙΑ**", "**ΝΕΜΕΑ**", "**ΠΥΘΙΑ**" and two minor games "**ΝΑΑ**" (at Dodona) and another one not deciphered yet.

Although knowing which game is about to occur has no astronomical value, it holds a huge cultural significance and serves as a common basis for chronology. Again this added to the fact that the Antikythera mechanism was not a scientific instrument but rather a technological “gadget”, ideal to be demonstrated in small groups.

3. The left subsidiary dial symmetrical to the Olympic, is probably the Callippic dial but the absence of evidence means that confirmation is unlikely.

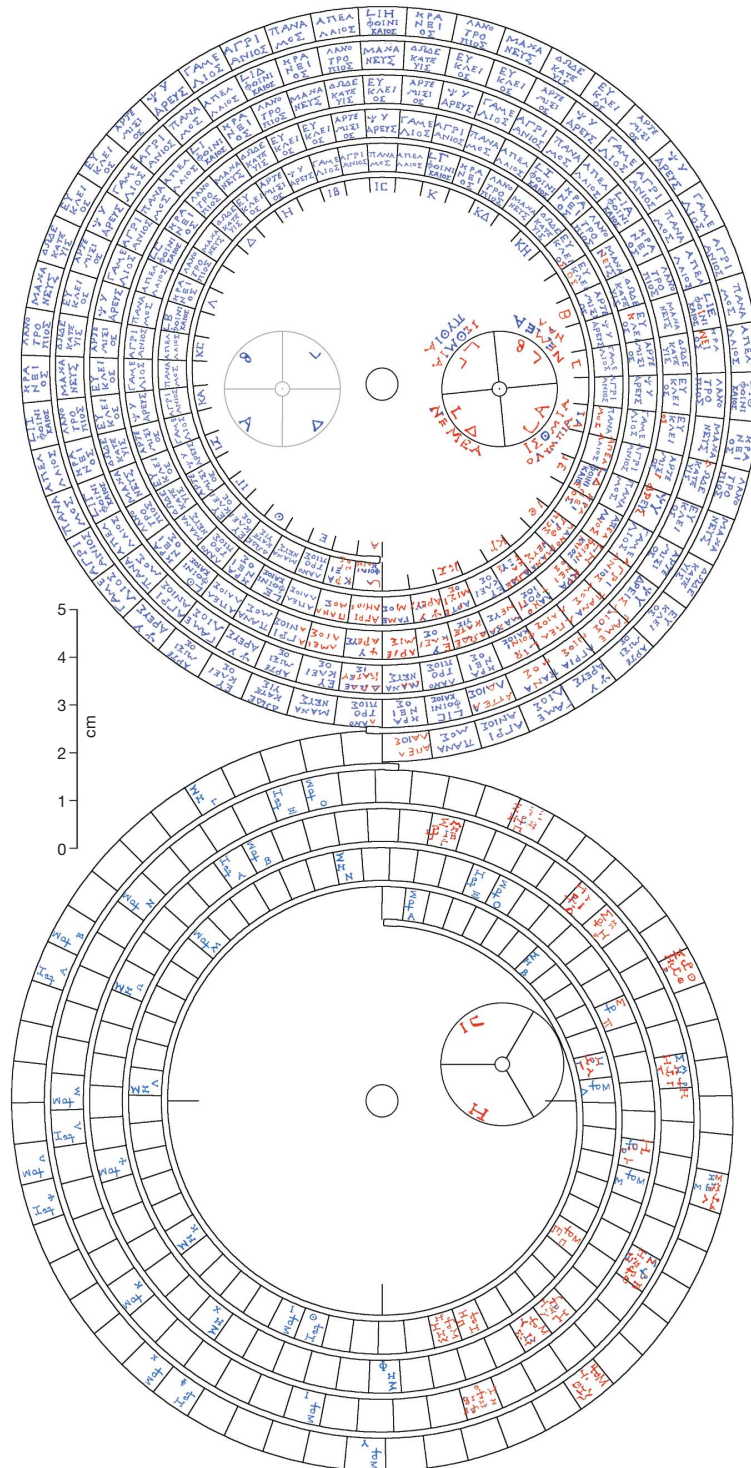

Fig.46: Diagram for the back dials (Freeth et al., 2008)

The 2008 Nature article was the second and last article by the Antikythera Mechanism Research Project for the time being (July 2013). The involved scholars continued to work individually or in small groups.

4.3 Latest Press



Fig.47: The mechanism's front dial (Freeth, 2009)

Since the initial publication of the AMRP, Freeth was skeptic about Wright's proposed schema for the front dial that included all the five known planets (Marchant, 2010a). Despite that, he published an article for the Scientific American magazine in 2009 where he described in short the conducted research by his team and other scholars as well as the "mechanics" of this Hellenistic technological miracle. Although the presented model includes a front dial with pointers for the Sun and Moon, the five known planets and a date pointer for the Egyptian calendar (Fig.47), Freeth acknowledges Wright's model as a possible one, but notes again that there are no enough evidence to support this schema. He also refers to some strange findings on the main gear, some "remnants of bearings stand" that indeed suggest the presence of planets. Finally Freeth introduces the reader to the still open question of the maker's identity and notes again as before findings that witness strong connections with Archimedes (Freeth, 2009).

As we have seen so far the mainly accepted models of the Antikythera mechanism since Price, had proposed or at least accepted the possibility of a front diary with concentric pointers for all the known celestial objects. In 2010 James Evans, Christian Carman and Alan Thorndike purposed a completely different arrangement for the front dial and tried to solve the problem of depicting the varying speed of Sun (Evans, Carman, &

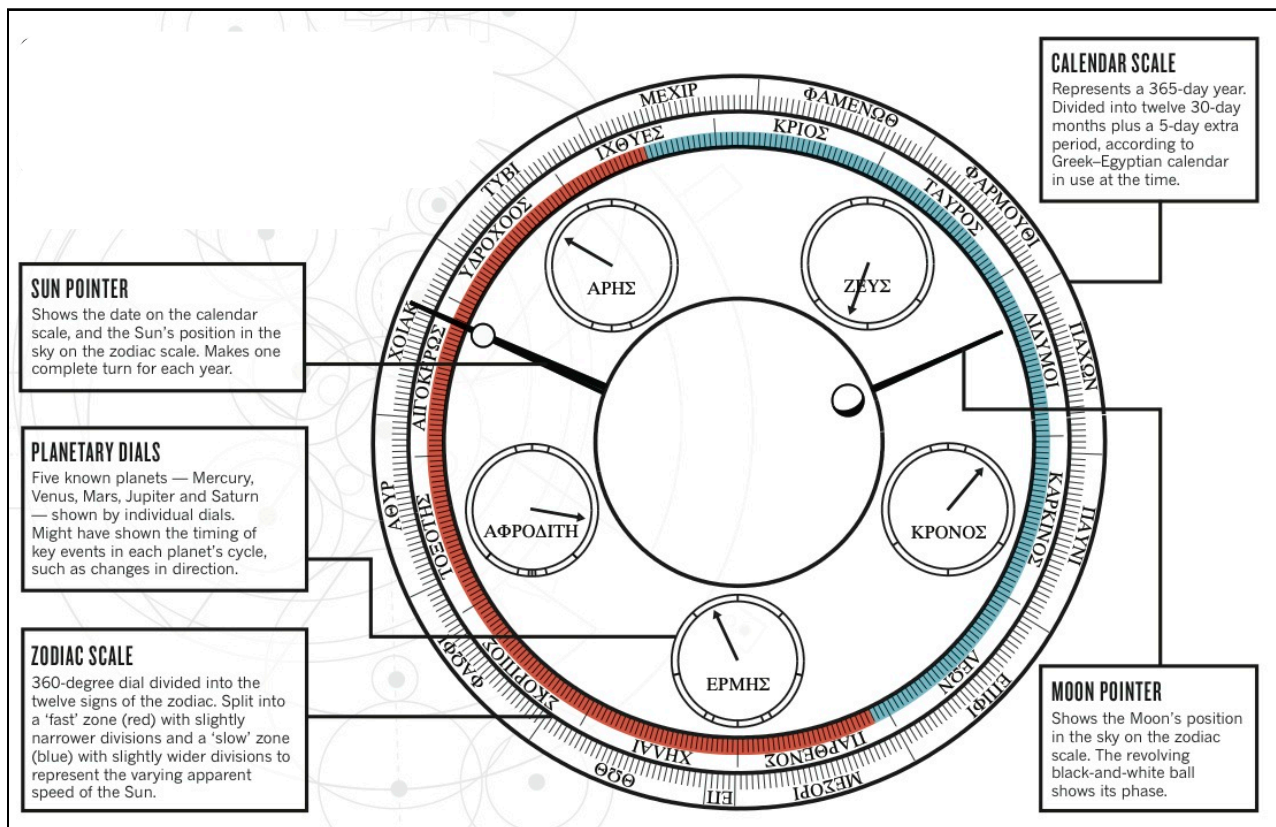

Fig.48: The new proposed front dial by Evans, Carman and Thorndike (Marchant, 2010b)

Thorndike, 2010). The team studied the survived parts of the zodiac scale and noticed a difference of the division widths. They suggested that the zodiac was divided in two parts: a “fast” zone with slightly narrower widths and a “slow” zone with slightly wider divisions. And there was a good reason of why doing that: the mechanism’s maker instead of using epicyclic gears to display the Sun’s irregular movement, he used this technique that “produced” the “illusion” of slowing and speeding-up, a used scheme by the Babylonians known as System A (Evans et al., 2010). But there was an implication: if correct, the proposed schema would affect the accurate position of the other celestial known bodies. So Evans suggested that the planets and the Moon could have their own dials with pointers moving at a constant speed, showing principal events of their synodic cycle and not necessarily their positions on the sky.

It’s been almost a year since Evans proposed his alternative scheme for the front dial (a common research question) and Mike Edmunds had begun to focus on a rather simple but previously not researched aspect of the Antikythera mechanism: how well did the mechanism work (Edmunds, 2011; Edmunds & Freeth, 2011)? Edmunds’ first thought was how the observed manufacturing gear errors could affect the mechanism’s accuracy. By applying computational methods in a well constructed computer simulation he found that the calendrical dials e.g. the Metonic and Saros dials were sufficiently accurate for their purpose but the Moon position indicator resulted an error by 20 degrees, a large

one if the user's intention was to predict the Moon's position in the sky. The results for Edmunds were implying that the mechanism was not designed with accuracy in mind but rather with approximate prediction of the astronomical phenomena.

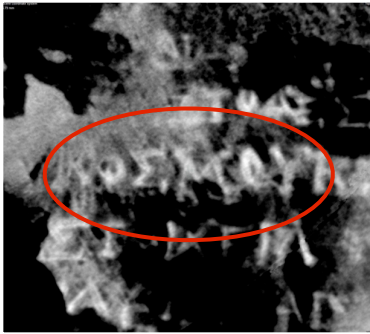

Fig.49: The inscription "of the Cosmos" (Freeth & Jones, 2012)

In February of 2012 February Tony Freeth and Alexander Jones based on some physical evidences (pillars) and an inscription from a fragment that was initially part of the mechanism's back cover, proposed a newer model that included the planets at the front dial. The inscription is part of the back cover from fragment B and the two researchers read the words like "ΚΟΣΜΟΥ" (of the Cosmos) and others that describe the motion of each planet through a "circle". As previously shown the mechanism was indeed carrying operation instructions but

now it was clear that the mechanism also included a description of its external features such as pointers bearing little spheres to represent the five known planets. Freeth and Jones also commented on Evans' model by stating that (Freeth & Jones, 2012):

"...we are not convinced that the Mechanism's designer intentionally represented solar anomaly through nonuniform graduation of the zodiac ring instead of by epicyclic gear-work..."

The five known planets as well as the Sun and Moon were represented by spheres placed at distances, according to their proximity to the Earth: Moon, Mercury, Venus, Sun, Mars, Jupiter and Saturn (Fig.50). Since the inscriptions refer to a "golden sphere" (Sun) and according to ancient tradition of using "magic stones" as markers for the planets, the team used the following "materials" for their computer model: Moon (silver),

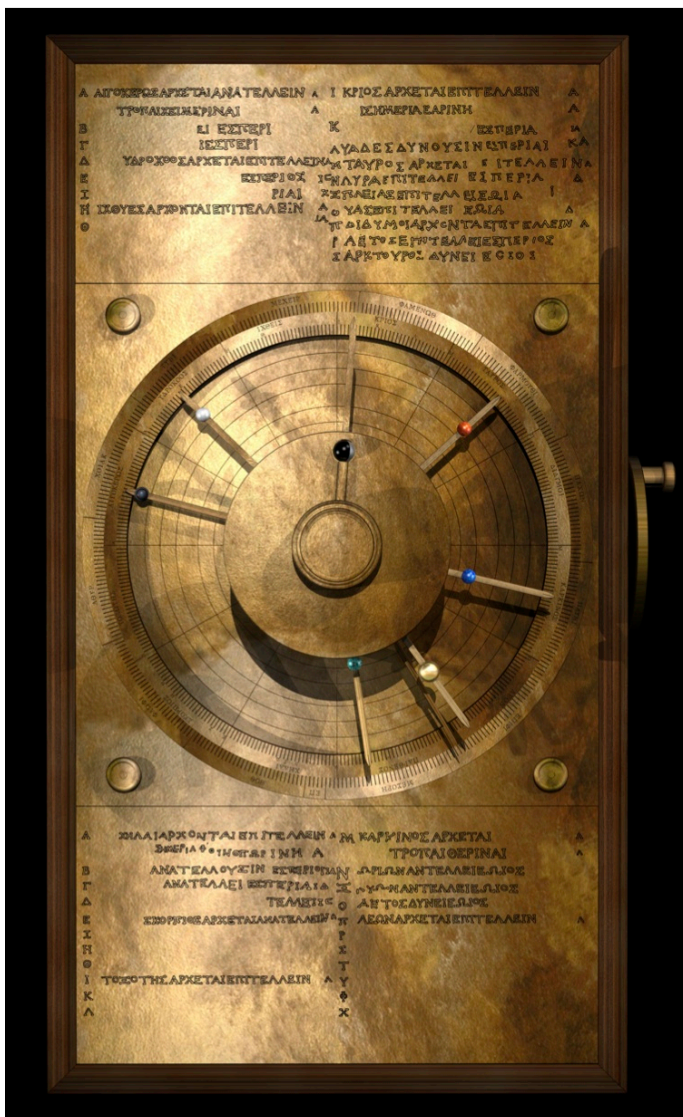

Fig.50: The mechanism's front dial (Freeth & Jones, 2012)

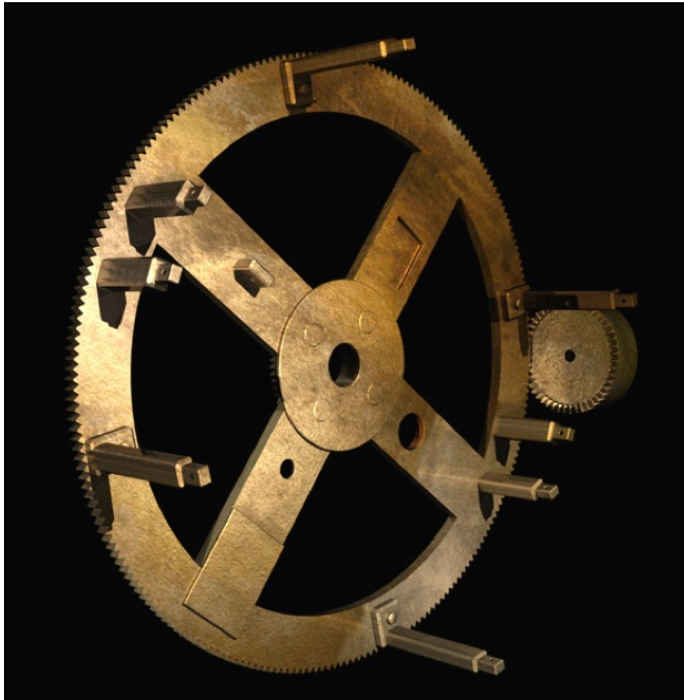

Fig.51: The eight pillars on the Main Drive Wheel
(Freeth & Jones, 2012)

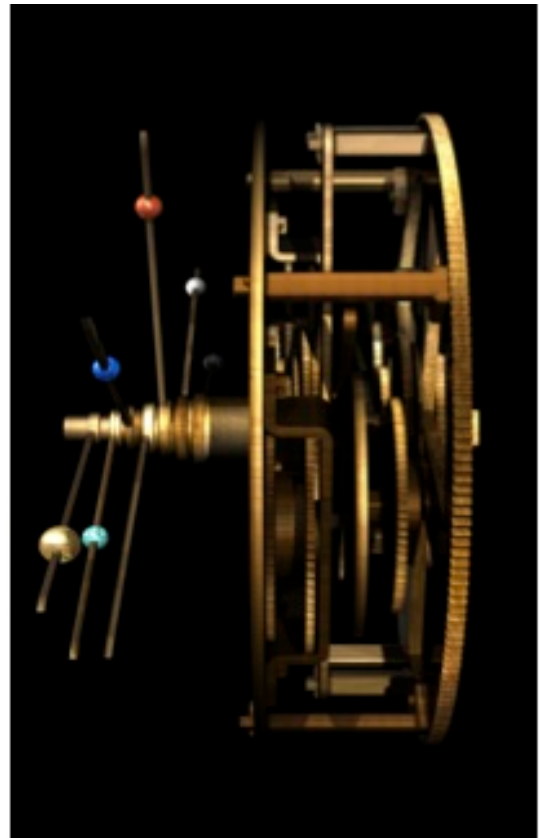

Fig.52: The planet module and pillars
(Freeth & Jones, 2012)

Mercury (turquoise), Venus (lapis lazuli), Sun (gold), Mars (red onyx), Jupiter (white crystal) and Saturn (obsidian). It is noticeable that Freeth had revised the spheres arrangement of his previous model (compare Fig.47 & Fig.50), since there were known mechanical problems for such an arrangement as noted earlier by Wright (Wright, 2006a). For Freeth and Jones the analysis of remnants that suggest the existence of pillars on the Main Drive Wheel was critical for their model. They identified four short and four long pillars around the circumference ring of the Main Drive Wheel (Fig.51); these pillars serve a special function as they support (metaphorically and literally) the proposed planetary module (Fig.52). Finally Freeth and Jones following Edmunds investigated how well the mechanism could have predict the motion of Mars and noted that although the mechanism was and still is a technological miracle of its era, neither the astronomical theory nor the mechanism itself were very accurate.

Three months later from May 7 until May 11, the 4th International Symposium on the History of Machines and Mechanisms took place at the University of Amsterdam, in Netherlands. This is the time that we “trace” Michael Wright’s last thoughts on the subject. Wright presents in short findings and models by other scholars and then describes and justifies his model. He states that there are no reasons to make changes to his model (Wright, 2012):

“So far I see no reason to make any significant changes to this reconstruction. As for the mechanism driving the planetary pointers, the arrangements that I have put forward represent just one set of possibilities among many. It is interesting to consider other suggestions, but there is as yet no compelling reason to reject my arrangement in favor of another.”

Maybe this is the reason of why Wright acknowledged only the new proposed schema by Evans (Evans et al., 2010) although other scholars too had already published their work with new findings (e.g. Edmunds, 2011).

Since 2002 and for every five years scholars from around the globe meet in Tripolis, Greece for a workshop devoted to radio astronomy. In June 2012 this workshop was dedicated in linking modern and ancient astronomical technology through the Antikythera theme as its name confirmed: “From Antikythera to the Square Kilometer Array: Lessons from the Ancients”. Alexander Jones as well as others members of the AMRP team were there and presented their most recent thoughts and findings on the subject.

	agriculture	navigation	medicine	civil life and religion	astronomical research	geography	astrology
Longitudes of Sun, Moon, Planets					X		X
Lunar phases	X	X	X		X		
Solstices and equinoxes	X	X	X		X		
Stellar risings and settings	X	X	X		X		
Egyptian calendar					X		X
Lunisolar calendar	X	X	X	X	X	X	X
4-year cycle				X			
Solar and lunar eclipses					X	X	X

Table 1: Mechanism’s generated data and correlation with fields (Jones, 2012)

Alexander Jones had gathered clues that were suggesting plausible answers regarding the mechanism’s purpose and owner (Jones, 2012). First he summarized the data types that the mechanism was offering to its user: longitudes of the Sun, Moon and planets, lunar phases, solstices and equinoxes, stellar rising and settings, Egyptian calendar, lunisolar calendar, 4-year cycle (Olympiads) and finally solar and lunar eclipses. Then he correlated these data with fields of human activities of the Hellenistic period (Table 1). From this he concluded that the Antikythera mechanism was not a machine “dedicated”

Feature on Mechanism	Related chapters in Geminos
Zodiac	1. On the circle of the zodiacal signs.
Motion of Sun, Moon, planets	1. On the circle of the zodiacal signs (discussion of solar longitudinal motion and anomaly). 12. That the planets make a movement contrary to that of the cosmos (longitudinal motion of Sun, Moon, and planets and stations and retrogradations of planets). 18. On the exeligmos (lunar motion in longitude and anomaly).
Moon's phases	9. On phases of the Moon.
First and last visibilities of stars	13. On risings and settings. 17. On weather-signs from the stars.
Egyptian calendar	8. On months (discussion of Egyptian calendar and its shifting relative to the seasons).
Metonic and Callippic dials	8. On months (discussion of Greek calendars, intercalation cycles, 29-day and 30-day months).
Four-year dial with games	<i>No correspondence.</i>
Saros and exeligmos dials	10. On the eclipse of the Sun. 11. On the eclipse of the Moon. 18. On the exeligmos.

Table 2: Features of the Antikythera mechanism related to Geminos's book (adapted from Jones, 2012)

to a specific field of practical application and if someone was interested in data there were other known, less expensive and more accurate methods to generate them. The mechanism's general purpose of use prompted Jones to seek for parallels with artifacts contemporary to the Antikythera mechanism and Geminos's book "Introduction to the Phenomena" was an excellent candidate. The book was written during the first century BC for the sake of nonspecialist readers containing its time knowledge in astronomy, geography, astrology, astral weather prediction and calendrics. This tendency of popularizing astronomical knowledge was common in Greco-Roman times and there was no sharp distinction between specialists and non-specialists' texts. Jones saw that the mechanism's features and the book of Geminos shared great parallels (Table 2) and noted that the mechanism could have served the same didactic role: explain topics such as astronomy, in a simple way without the presence of technicalities and mathematics.

Moreover the mechanism did that by taking advantage an presentation mode impossible for a textbook.

In order to identify the owner's identity, Jones noted that there are two key facts that must be acknowledged: First, the mechanism was on board a commercial vessel heading from the east side of the Aegean Sea where it was probably manufactured into the



Fig.53: Greek cities with known calendars. The area of the squares is proportional to the percentage of coincidence with the Antikythera mechanism's calendar (Anastasiou, 2012 (accepted) cited in Seiradakis, 2012)

central part of the Mediterranean to the person who commissioned it. Secondly, the engraved months were part of the Corinthian calendar, used in Corinth, Epirus, Illyria and Corcyra (Kerkyra, Corfu). Although it was previously suggested that Syracuse also

Antikythera Mechanism	Kerkyra	Dodona	Bouthrotos	Tauromenion	Athens	Rhodes
ΦΟΙΝΙΚΑΙΟΣ	ΦΟΙΝΙΚΑΙΟΣ	ΦΟΙΝΙΚΑΙΟΣ	ΦΟΙΝΙΚΑΙΟΣ	ΙΤΩΝΙΟΣ	ΜΕΤΑΓΕΙΤΝΙΩΝ	ΚΑΡΝΕΙΟΣ
ΚΡΑΝΕΙΟΣ			ΚΡΑΝΕΙΟΣ	ΚΑΡΝΕΙΟΣ	ΒΟΗΛΡΟΜΙΩΝ	ΛΑΛΙΟΣ
ΛΑΝΟΤΡΟΠΙΟΣ		ΛΑΙΟΤΡΟΠΙΟΣ		ΛΑΝΟΤΡΟΣ	ΠΥΑΝΟΨΙΩΝ	ΘΕΣΜΟΦΟΡΙΟΣ
ΜΑΧΑΝΕΥΣ	ΜΑΧΑΝΕΥΣ	ΔΑΤΥΙΟΣ		ΑΠΟΛΛΩΝΙΟΣ	ΜΑΙΜΑΚΤΗΡΙΩΝ	ΔΙΟΣΘΥΟΣ
ΔΩΔΕΚΑΤΕΥΣ	ΔΩΔΕΚΑΤΕΥΣ			ΔΥΩΔΕΚΑΤΕΥΣ	ΠΟΣΙΔΕΩΝ	ΘΕΥΔΑΔΙΣΙΟΣ
ΕΥΚΑΕΙΟΣ	ΕΥΚΑΕΙΟΣ		ΕΥΚΑΕΙΟΣ	ΕΥΚΑΕΙΟΣ	ΓΑΜΗΛΙΩΝ	ΠΕΔΑΓΕΙΤΝΙΟΣ
ΑΡΤΕΜΙΣΙΟΣ	ΑΡΤΕΜΙΤΙΟΣ			ΑΡΤΕΜΙΤ/ΣΙΟΣ	ΑΝΘΕΣΤΗΡΙΩΝ	ΒΑΡΡΟΜΙΟΣ
ΨΥΔΡΕΥΣ	ΨΥΔΡΕΥΣ		ΨΥΔΡΕΥΣ	ΔΙΟΝΥΣΙΟΣ	ΕΛΑΦΗΒΟΛΙΩΝ	ΣΜΙΝΘΙΟΣ
ΓΑΜΕΛΙΟΣ		ΓΑΜΙΛΙΟΣ	ΓΑΜΙΛΙΟΣ	ΕΛΛΟΚΙΟΣ	ΜΟΥΝΥΧΙΩΝ	ΑΡΤΑΜΙΤΙΟΣ
ΑΓΡΙΑΝΙΟΣ			ΑΓΡΙΑΝΙΟΣ	ΔΑΜΑΤΡΙΟΣ	ΘΑΡΓΗΛΙΩΝ	ΑΓΡΙΑΝΙΟΣ
ΠΑΝΑΜΟΣ	ΠΑΝΑΜΟΣ	ΠΑΝΑΜΟΣ	ΠΑΝΑΜΟΣ	ΠΑΝΑΜΟΣ	ΣΚΙΡΟΦΟΡΙΩΝ	ΥΑΚΙΝΘΙΟΣ
ΑΠΕΛΛΑΙΟΣ		ΑΠΕΛΛΑΙΟΣ		ΑΠΕΛΛΑΙΟΣ	ΕΚΑΤΟΜΒΑΙΩΝ	ΠΑΝΑΜΟΣ
Coincidence	100%	86%	100%	58%	17%	33%

Table 3: Comparison of the Antikythera Mechanism calendar with the calendar of several ancient cities. Differences are marked with red letters. (Seiradakis, 2012)

used the Corinthian calendar it is now evident that some months of the Syracusan calendar were not found on the mechanism.

If the mechanism's dating is correct (around 70-50 BC) then the only known comparable device of its era would be the "Sphaera" of Posidonios from Rhodes (Ποσειδώνιος ὁ Ῥόδιος) as accounted by Cicero in *De Natura Deorum*. Jones states that the person who authorized the construction of the Antikythera mechanism should be "a prosperous philosopher and teacher, deeply interested in the physical world though not necessarily in the technicalities of mathematical astronomy" and that the mechanism could have come from workshops as Posidonios's by "a pupil or associate of Posidonios who lived in or about Epirus". This conclusion seems to be in agreement with the suggestions made by Seiradakis and Anastasiou (Anastasiou, 2012 (accepted); Seiradakis, 2012).

These are our last steps in our linear "time travel": even after a century of research, the Antikythera Mechanism still holds some of its features hidden but scholars are determined to unlock them in the near future. The Antikythera "bug" amplified its hosts' ambition and curiosity, while the interaction of different personalities complicated things further. An additional factor, technology, played a key-role and led research to unknown paths inconceivable before. We proceed by presenting our current understanding about this enigmatic artifact.

II

CURRENT UNDERSTANDING

PART II: CURRENT UNDERSTANDING

5. The Fragments



Fig.54: The Antikythera Mechanism fragments (Tony Freeth et al., 2006).

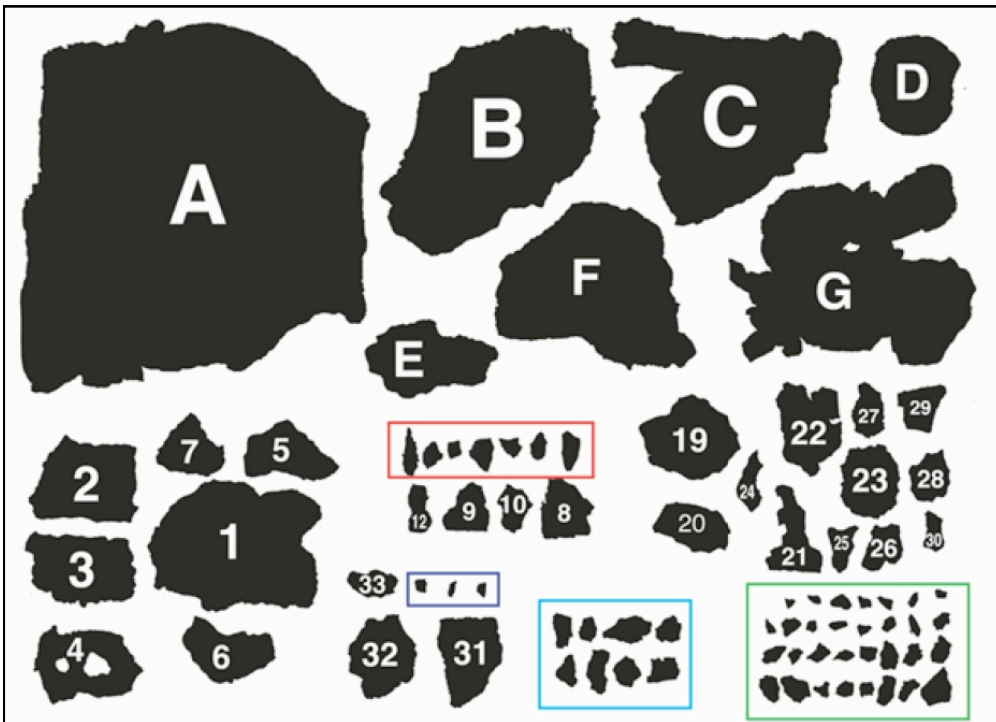

Fig.55: A labeled shadow-gram which identifies the fragments (Tony Freeth et al., 2006).

The Antikythera mechanism consists of 82 separate fragments, probably all of them belonging to the original device. There are 7 big fragments labeled with letters A-G and 75 smaller labeled with numbers 1-75. Although initially constructed from bronze after 2,000 years beneath the sea surface the fragments are now mainly consist of bronze corrosion products with very little free metal surviving. Each side of the fragment is labeled with numbers 1 and 2, meaning side 1 and side 2. Numbers 1 and 2 do not indicate the front and the back of a fragment since there are fragments whose orientation is not yet known. The survived part of the mechanism consists totally of 30 gears. From these gears only 12 of them are visible on the surface while the rest were identified through X-ray techniques. Fragment A is the largest fragment and contains 27 of the surviving gears, while the rest three are found in each of Fragments B, C and D. So when referring to Fragment A-1 does not necessarily mean the front of Fragment A.

Fragment A	Fragment B	Fragment C	Fragment E	Fragment F	Fragment G	Fragment 19
Upper left quarter of Saros spiral: divisions and inscriptions	Bottom right third of the Metonic dial& inscriptions	Upper right of the front dial (calendar & zodiac)	Six inscriptions from the upper right of the Saros spiral	16 inscriptions from the lower right of the Saros dial	Parts from FragmentC	Back door inscriptions for the Callippic cycle
Exeligmos dial: inscriptions & dial from	Back door			Remnants of the wooden housing		
Back door inscriptions	A gear from olympic dial					

Table 4: Fragments and related parts of the Antikythera Mechanism.

Table 4 presents the correspondence of Fragments with their original position at the mechanism. Note that we don't have recognize yet the origin of each Fragment in relation with their original placement.

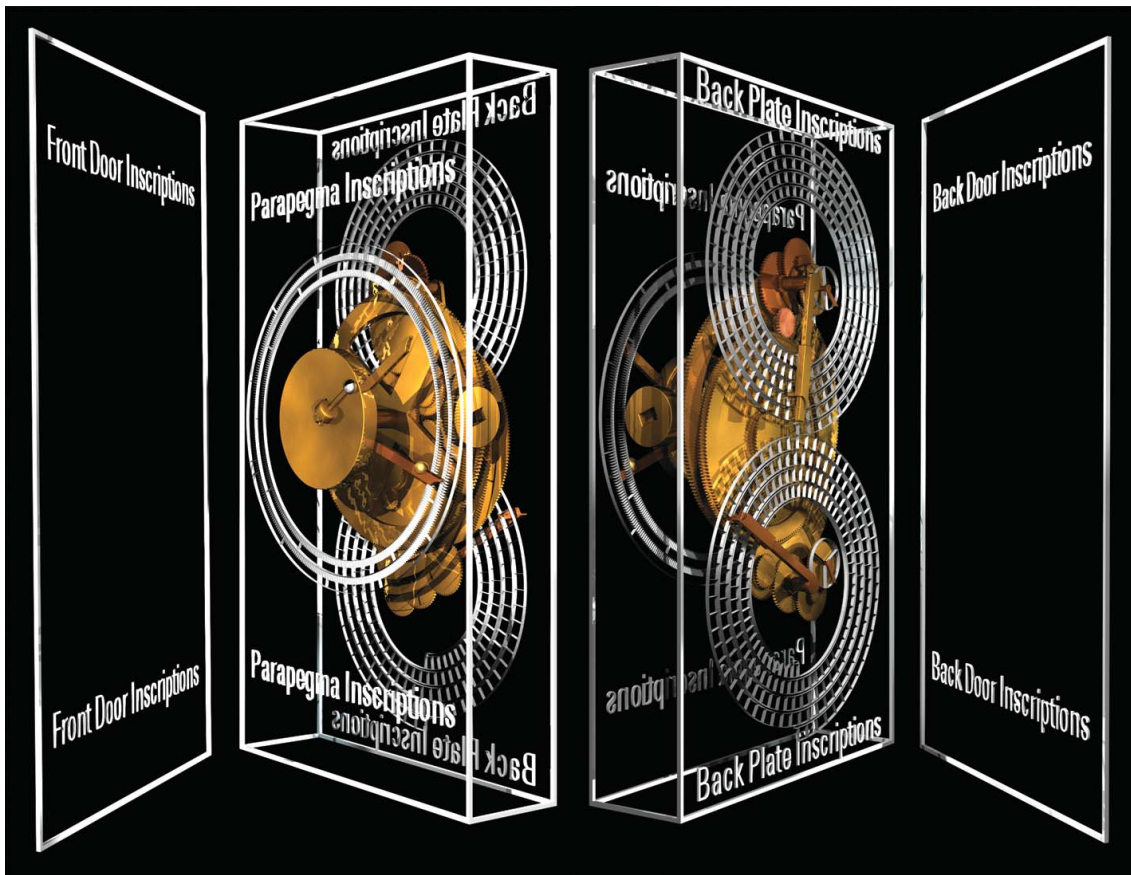

Fig.56: Overview of the Antikythera Mechanism (Tony Freeth et al., 2006)



Fig.57: Overview of the Antikythera Mechanism (Edmunds & Freeth, 2011)

6. Overall Design

The mechanism was probably hand-driven, originally housed in a wooden framed case of (uncertain) overall sized 32x20x10cm so it was a portable device. It had front and back doors with astronomical inscriptions covering most of the mechanism's exterior. The front of the mechanism consists of a co-axial display with the Sun, Moon and the five known planets probably represented by small spheres. There were two concentric graduated rings (dials): the outer (originally) movable scale is a calendar with the



Fig.58: Overview of the Antikythera Mechanism (Freeth, 2012)

Egyptian names of the months **ΠΑΧΩΝ** (Pachon), **ΠΑΥΝΙ** (Payni) and the inner is displaying the Greek zodiac [**ΚΡΙΟΣ** (Aries), **ΤΑΥΡΟΣ** (Taurus), **ΔΙΔΥΜΟΙ** (Gemini), **ΚΑΡΚΙΝΟΣ** (Cancer), **ΛΕΩΝ** (Leo), **ΠΑΡΘΕΝΟΝ** (Virgo), **ΧΗΛΑΙ** (Scorpio's Claw, i.e., Libra), **ΣΚΟΡΠΙΟΣ** (Scorpio), **ΤΟΞΟΤΗΣ** (Sagittarius), **ΑΙΓΟΚΕΡΩΣ** (Capricorn), **ΥΔΡΟΧΟΟΣ** (Aquarius), **ΙΧΘΕΙΣ** (Pisces)]. In between these dials were (probably) placed the Parapegma inscriptions: a star calendar showing rising and settings at dawn or evening of particular stars or constellations. Each celestial object had a pointer indicating its position on the zodiac scale and the Moon had an additional phase indicator. At the back of the mechanism were placed two main spiral shaped dials and three subsidiary dials. The Main Upper Back dial was depicting the 19-year Metonic cycle with engraved the names of Corinthian months: [**ΦΟΙΝΙΚΑΙΟΣ** (Phoinikaios), **ΚΡΑΝΕΙΟΣ** (Kraneios), **ΛΑΝΟΤΡΟΠΙΟΣ** (Lanotropios), **ΜΑΧΑΝΕΥΣ** (Machaneus), **ΔΩΔΕΚΑΤΕΥΣ** (Dodekateus), **ΕΥΚΛΕΙΟΣ**

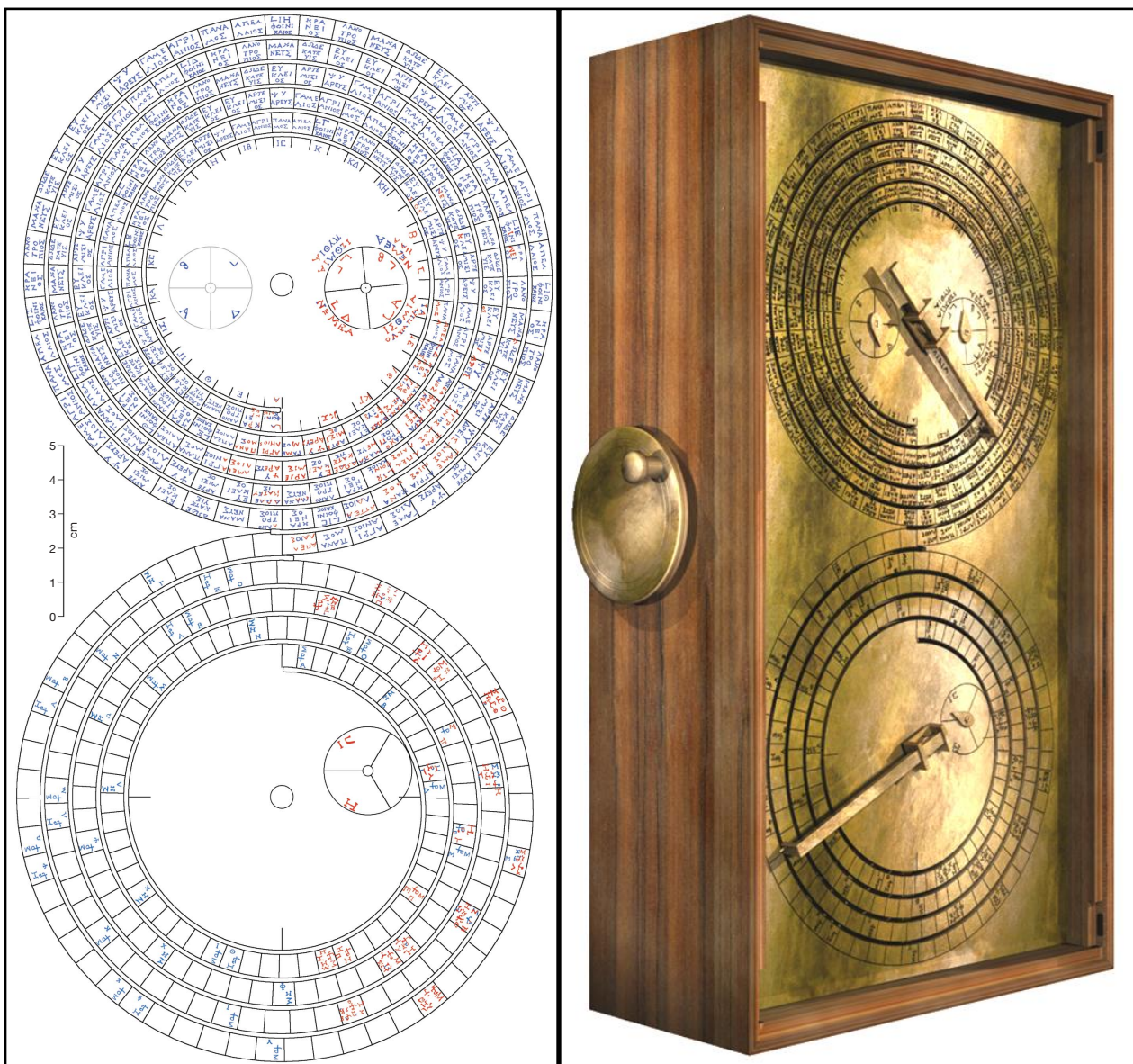

Fig.59: Diagram for the back dials (Freeth et al., 2008)

(Eukleios), **ΑΡΤΕΜΙΣΙΟΣ** (Artemisios), **ΨΥΔΡΕΥΣ** (Psydreus), **ΓΑΜΕΙΛΙΟΣ** (Gameilios), **ΑΓΡΙΑΝΙΟΣ** (Agrianios), **ΠΑΝΑΜΟΣ** (Panamos), **ΑΠΕΛΛΑΙΟΣ** (Apellaios)].

The Main Upper Back dial was also equipped with two subsidiary dial: the right one was an Olympiad dial indicating which of the major games was about to happen [**ΙΣΘΜΙΑ**, **ΟΛΥΜΠΙΑ** (**ΛΑ**: year 1), **ΝΕΜΕΑ**, **ΝΑΑ** (**ΛΒ**: year 2), **ΙΣΘΜΙΑ**, **ΠΥΘΙΑ** (**ΛΓ**: year 3), **ΝΕΜΕΑ**, (**ΛΔ**: year 4)] and the left one was probably following the 76-year Callippic cycle. The Main Lower Back dial was following the 18-year Saros cycle and its subsidiary dial was depicting the Exeligmos cycle. Both Main dials were equipped with a “stylus” that had an extendable pointer following the spiral gaps.

7. Functions

As it is obvious from our presentation so far the Antikythera Mechanism’s functions were:

1. Giving the Sun’s position in the zodiac and showing its variable motion.
2. Giving the position of the Moon in the zodiac and presenting the Moon’s phases during the month. The Moon pointer was also depicting its motion with variable speed around the zodiac.
3. Giving the position of the five known planets in the zodiac and their variable motion (no hard evidence).
4. A solar calendar using Egyptian months.
5. Prediction of solar and lunar eclipses (Saros and Exeligmos dials)
6. Prediction of the Moon’s position in the sky (Metonic and Callippic dials)
7. Giving the days of each month and year as well as the occurring dates for the Olympiad games.

8. Purpose and Maker

Unfortunately, there are no hard evidence about who and why built the Antikythera Mechanism, only speculations; the mechanism’s maker could be someone from Hipparchus or Apollonius school who built the mechanism as a scientific or educational instrument or simply as a “toy” for a wealthy person.

III

EDUCATIONAL POTENTIAL

PART III: EDUCATIONAL POTENTIAL

9. e-Learning: An Introduction

At this section we present the educational potential that the Antikythera Mechanism (AM) holds, the two categories of built models (solid & computer) and finally we try to examine if current AM simulations are proper for the use in educational contexts, in accordance to e-Learning design rules. For that reason, supporting the basic prerequisite knowledge, introductory chapters for e-Learning and e-Learning design rules (guidelines) are provided in the beginning of the chapter.

9.1 How Do We Learn?

Identifying the processes and fundamentals of learning has been the holy grail for psychologists and social scientists since the dawn of our century. During the past one hundred years many theories and practices were developed, tested and criticised. Throughout this period psychologists have developed three major metaphors of learning and instruction (Mayer, 1996a). Table 6 summarises the characteristics of each one.

Table 6: Three Metaphors of Learning (adopted from Mayer & Clark, 2011)

<i>Metaphor of Learning</i>	<i>Learning Is:</i>	<i>Learner Is:</i>	<i>Instructor Is:</i>
Response Strengthening	Strengthening or weakening of associations	Passive recipient of rewards and punishments	Dispenser of rewards and punishments
Information Acquisition	Adding information to memory	Passive recipient of information	Dispenser of information
Knowledge Construction	Building a mental representation	Active sense maker	Cognitive guide

These metaphors reflect our views of learning and instruction; each one determines the teacher's - student's role and the instruction method used in each case. According to Mayer and Clark the first approach is not wrong but incomplete while the second is wrong because it doesn't require learner's psychological engagement (2011). The Response strengthening metaphor considers learners as response strengtheners (encouraging specific responses) and the Information acquisition metaphor regards learners as information processors (learning is considered as an action of filling the "empty mind" with information). On the contrary the Knowledge construction approach considers learners as sense makers and is based on *Paivio's dual coding theory* (Paivio,

1986), *Baddeley's model of working memory* (Baddeley, 1992), *Sweller's cognitive load theory* (Sweller & Chandler, 1994; Sweller, Chandler, Tierney, & Cooper, 1990), *Wittrock's generative theory* (Wittrock, 1989), and *Mayer's SOI model* (see Figure 61) of meaningful learning (Mayer, 1996b).

The Knowledge construction approach states that learning is regulated by three major principles and three major cognitive processes. The principles are:

- **Dual channels:** the way that human's cognitive system filters/processes the multimedia stimuli. We have a channel for processing visual/pictorial material and another one for auditory/verbal material.
- **Limited capacity:** our "power" of processing is limited and only a small amount of information can be handled at each channel at the same time, and
- **Active processing:** learning occurs when appropriate cognitive processes take place that foster active processing the stimuli, active accessing to relevant prior knowledge and intergrading the outcome into a coherence structure.

Fig. 60: The Knowledge Construction Metaphor (adapted from Mayer & Clark, 2011)

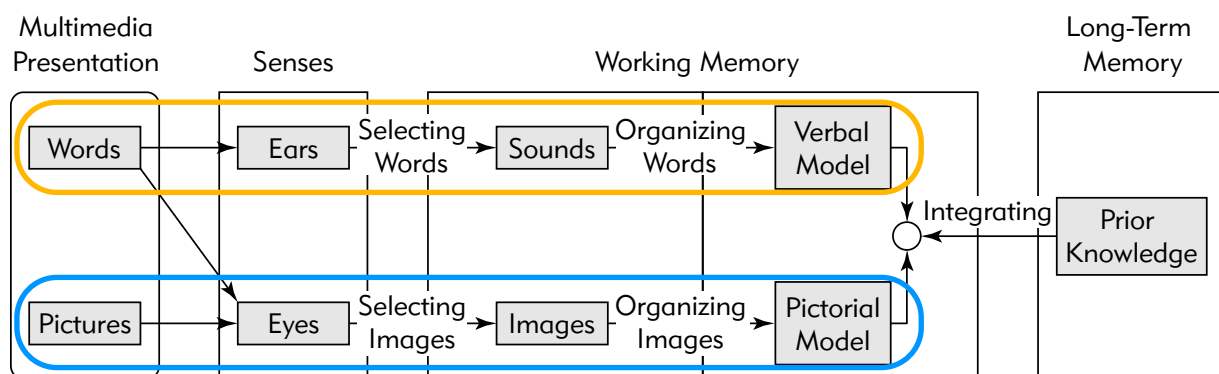

As we can see at Figure 60 the dual channel principle is represented by the two rows (orange box for the auditory/verbal channel, blue box for the visual/pictorial channel). The limited capacity principle is represented by the Working Memory box and the active processing memory principle from the five phrases on arrows (selecting words, selecting images, organising words, organising images, integrating).

Mayer and Clark (2011) note that when attending a multimedia lesson, if the learner pays attention then he/she selects some of the presented multimedia for further processing in working memory. Afterwards the material is organised into a pictorial and

verbal model and finally the newly acquired material is connected with prior knowledge from the learner’s long-term memory.

As mentioned earlier, alongside with the pre-described principles, the Knowledge construction metaphor identifies three main cognitive processes taking place while learning happens: (a) *selecting words and images*, (b) *organising words and images* and (c) *integrating* the formed verbal and pictorial representations with each other and with existing knowledge. These processes shown at Figure 61 consist Mayer’s SOI model (Select - Organise - Integrate) and hold a major role in learning (Mayer, 1996b)¹⁵.

Fig. 61: Mayer’s SOI model (adopted from Mayer , 1996)

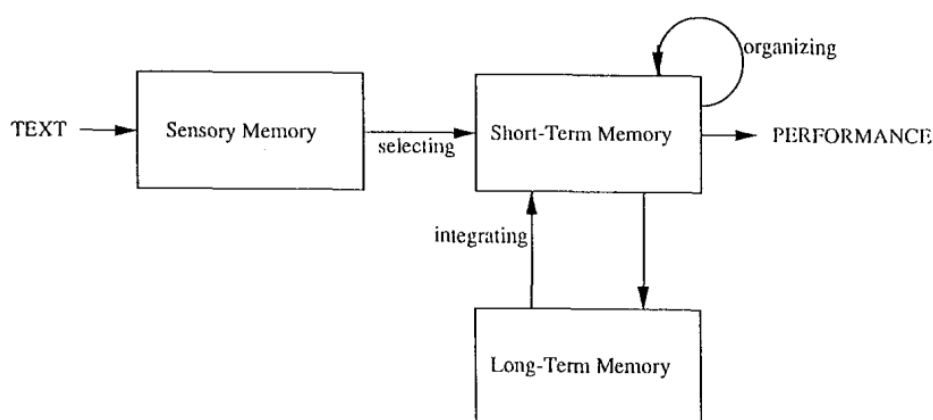

Mayer and Clark (2011) note that the design of e-learning lessons “*should be guided by an accurate understanding of how learning works*”. In order to facilitate learning we should help learner’s cognitive system to transform and integrate words and pictures according to the pre-described processes and principles, thus we should assist the learner to (Fig. 62):

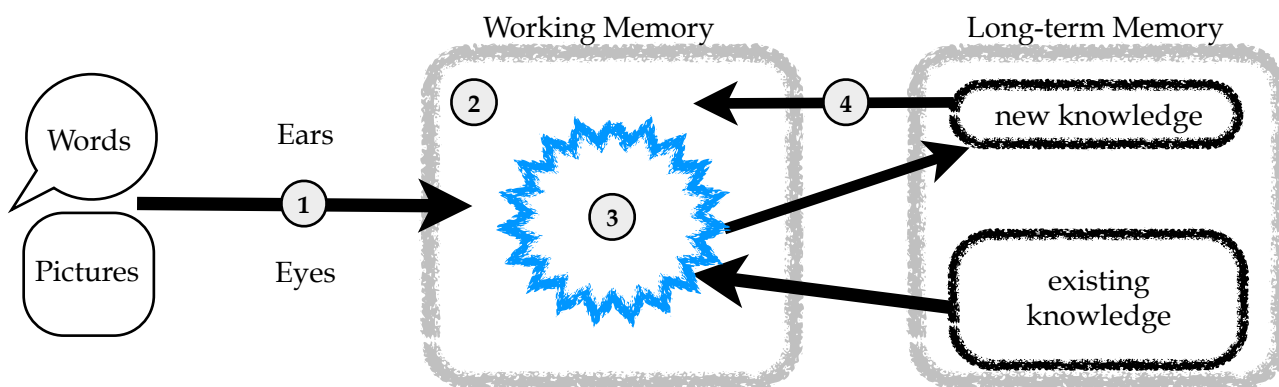

Fig. 62: How learning works

¹⁵ Although Figure 61 denotes only text, the model refers also to graphics and sounds.

- (1) Select the important information in the lesson
- (2) Manage the limited capacity of working memory
- (3) Integration of auditory and visual sensory information in working memory with existing knowledge in long-term memory
- (4) Retrieval of new knowledge and skills from long-term memory when needed

To sum up, we should provide techniques (in our case design rules) that respectively:

- ▶ Direct learner's attention to important information (limited capacity).
- ▶ Manage working memory's limited capacity (limited capacity).
- ▶ Integrate the organised material in working memory with knowledge in long-term memory.
- ▶ Allow retrieval and transfer of new knowledge.

9.2 Software for Learning

Since learning involves a change to learner's experience caused by instruction, at this point it is useful to present two definitions of instruction. According to Mayer et al. (2011) a broad definition of instruction is the following:

"We define instruction as the training professional's manipulation of the learner's experiences to foster learning. This definition has two parts: first, instruction is something that the instructional professional does to affect the learner's experience. Second, the goal of the manipulation is to cause a change in what the learner knows."

Alessi and Trollip (2001) define instruction in a more specific way by dividing it into four phases, that should occur in order to have effective and efficient learning:

- A) Presenting Information:** to teach something new the instructor must first present information
- B) Guiding the learner:** the instructor or an interactive medium observes the learner, corrects errors and give suggestions or hints
- C) Practicing:** learning is not complete when a learner can demonstrate that she currently understands the material. We usually want to learn something permanently rather than for a short time.
- D) Assessing learning:** learning should be evaluated in order to estimate the level of learning, the quality of teaching and future instructional needs.

In e-Learning these four phases should be taking place during instruction in order to facilitate successfully learning; this doesn't mean of course that all phases should be fulfilled by a computer/interactive system (Alessi & Trollip, 2001). The computer may be used for the three first phases of instruction or for a combination of two or more. Alessi and Trollip (2001) distinguish nine methodologies of interactive multimedia, with each one of them to include one or more phases of instruction (Table 5). As the authors note (Alessi & Trollip, 2001), it is unusual for an educational program to involve all four phases of instruction; most of them include two or three phases.

Table 5: Methodologies for Facilitating Learning (Alessi & Trollip, 2001)

Instructional Methodologies	Instruction Phase
1. Tutorials: presenting information and guiding the learner in initial acquisition.	(A)+(B)
2. Hypermedia: present information in an open-ended way. Each individual has different learning paths.	(A)
3. Drills: helping the learners to practice for fluency and retention.	(C)
4. Simulations: a model of a phenomenon or activity that users learn about through interaction.	(A)+(B) or (B)+(C) or (A)+(B)+(C) or (D)
5. Games: games with educational goals, learners practice their knowledge and skills.	most of them (C)
6. Tools: software that learners use in conjunction with other media or activities for achieving an educational goal	(A) or (B) or (C) or (D)
7. Open-ended learning environments: environments like simulations that support exploration.	(C)
8. Tests: determining what a person knows and does not know	(D)
9. Web-based learning: combination of methodologies	combination of phases

Each instructional methodology has certain characteristics (factors) that affect the appearance, function and **effectiveness** of the software but there are some instructional factors relevant to and **common to all** interactive multimedia (Alessi & Trollip, 2001). Thus a program's effectiveness can be at first qualified by examining its general features which are organized into the following categories:

1. Introduction of the program

- a. Title page
- b. Directions
- c. User Identification

2. Learner control

- a. What and how much control to provide
- b. Methods of control (buttons, menus, hyperlinks)
- c. Modes of control (mouse, keyboard, speech)

3. Presentation of information

- a. Consistency
- b. Modes of presentation (text, graphics, video, sound and animation)

4. Providing help

5. Ending a program

9.3 An Interesting Assumption

At section 9.1 "How do we learn" we've reviewed Mayer's (2011) three metaphors of learning that actually represent our understanding of human cognition. As we have seen the *Knowledge Construction* metaphor represents a more complete and "realistic" view of learning. It encapsulates three basic principles: dual channels, limited capacity and active processing. This last principle is of great importance for us since it is the "missing ring" for the transition from acquiring information to constructing knowledge; learners are not just empty vessels that need to be filled with information and new knowledge must be integrated with existing knowledge. Mayer (2011) note that we should **assist** the learner to select the important information, manage limited capacity of working memory, integrate auditory and visual information with existing knowledge and retrieve new knowledge when needed.

Since learning requires a form of instruction Alessi and Trollip's (2001) model of instruction was reviewed in order to gain more insight. As the authors note instruction consists of four phases: presenting information, guiding the learner, practicing and assessing learning. When these two approaches that represent the micro (cognition) and macro level (instruction) of learning are combined we can elicit the following interesting assumption: knowledge construction might occur if all the four phases of instruction take place. By this we don't argue that for knowledge construction all is needed is

including the four phases of instruction; we argue that efficient software for learning should embrace this approach. In addition many times the fourth phase of instruction is provided from an organisation, so in our case presenting information, guidance and practicing is sufficient. At Table 6 we show the four phases of instruction and the corresponding cognitive processes.

Table 6: Instruction phases corresponding knowledge const processes.

<i>Instruction Phases</i>	<i>Knowledge Construction processes</i>
<i>Presenting Information</i>	(1) Select the important information in the lesson (2) Manage the limited capacity of working memory (3) Integrate the organised material in working memory with existing knowledge in long-term memory
<i>Guiding the learner</i>	(3) Integrate the organised material in working memory with existing knowledge in long-term memory (4) Retrieval of new knowledge and skills from long-term memory when needed
<i>Practicing</i>	(4) Retrieval of new knowledge and skills from long-term memory when needed
<i>Assessing learning</i>	(4) Retrieval of new knowledge and skills from long-term memory when needed

Based on this assumption we can evaluate some efficiency aspects of software for learning that intend to teach the learner by determining which phases of instruction are included and classify educational software among Mayer’s three metaphors of learning.

9.4 Simulations: an educational prospective

A short review of relevant literature shows that the term simulation varies according to the adopted point of view (e.g. Computer Science). We would like now to introduce the notion of “educational simulation” since this type of simulation is our main scope. Although introducing a definition of educational simulations would be useful, the varying definitions among scholars and the rapid development of new technologies suggest that describing the characteristics of this multimedia type is much functional.

Alessi and Trollip (2001) identify two main categories of educational simulation: simulations *to teach about something* and simulations *to teach how to do something*. Each type can be also divided as follows (Alessi & Trollip, 2001):

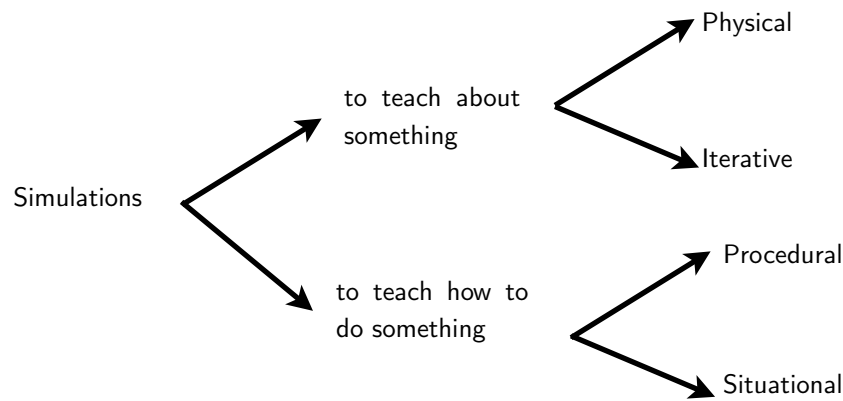

Fig.63: Classification of educational simulations (adapted from Alessi & Trollip, 2001)

Physical simulations: a physical object or phenomenon is represented on the screen, giving the user an opportunity to learn about it.

- ▶ **Iterative simulations:** the user “runs” the simulation over and over, after changing the values for several parameters.
- ▶ **Procedural simulations:** a sequence of actions to accomplish a goal
- ▶ **Situational simulations:** sometimes referred as a special type of procedural simulations dealing with the behaviors and attitudes of people or organizations in different situations.

9.5 Design Rules

A major problem when designing interactive systems is to deliver usable and safe to the user software products. Making a system that ensures usability is not a simple task; in order to overwhelm the difficulties that emerge during the design process, designers need guidance in the form of design rules.

Design rules can be classified in many ways. The most common categorization includes three types of design rules; **guidelines**, **principles** and **standards**. This classification results from considering two dimensions of the rule; authority and generality (Dix, Finlay, Abowd, & Abowd, 2004). Authority refers to the flexibility of the rule to be applied: it can be considered as a suggestion or as a strict rule. On the other hand generality defines how broad the rule is: it can either be applied to many design situations or it is more limited on a small area of appliance. As we can see at Fig.64 , principles are general and have low authority, standards are specific and have high authority while guidelines are more general and have low authority.

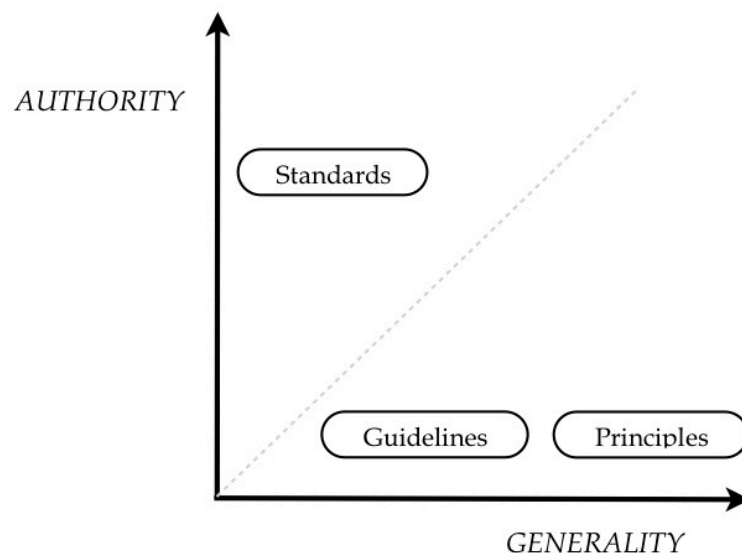

Fig.64: Design Rules classification

9.6 E-learning guidelines

Educational guidelines are suggestions based on our current understanding of how learning works for ensuring the effectiveness of educational software. At the following we present some guidelines regarding general and methodology-specific aspects of e-learning. The list of presented guidelines is not full but limited to the aspects that are useful for our purposes.

Mayer and Clark on “e-Learning and the Science of Instruction” (2011) define e-learning as follows (Figure 65):

*A combination of **content** and **instructional methods** delivered by media elements, such as words and graphics on a computer or mobile device intended to build job-transferable knowledge and skills linked to individual learning goals or organisational performance. May be designed for self-study or instructor-led training.*

Following this definition they provide us with guidelines, called *Principles* (not to confused with Principles stated at section 9.5), concerning the *content* (that is, the information to be delivered) which are called **Multimedia Principles** and the *instructional methods* (that is, techniques used to deliver the information) called **Principles for instructional methods and approaches**.

Figure 65: Mayer and Clark's e-Learning definition

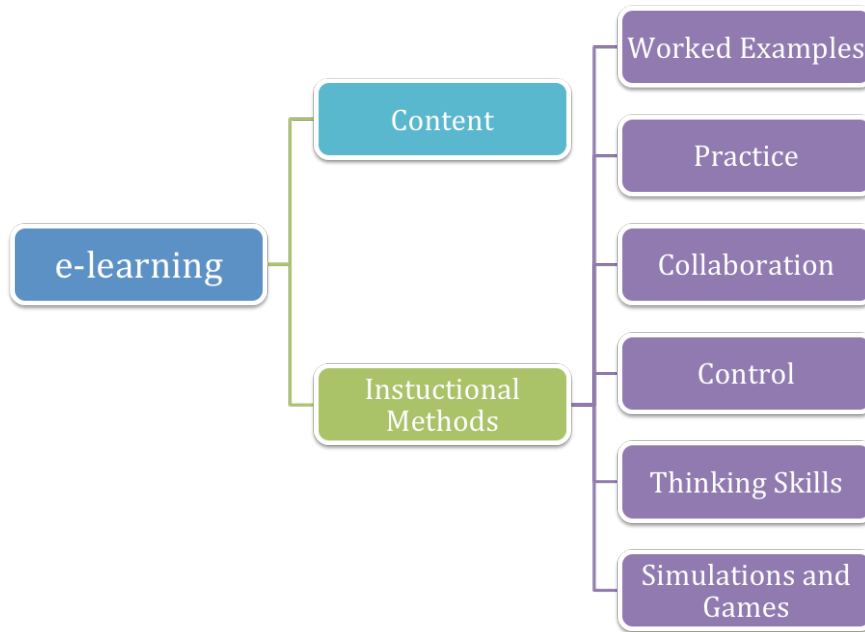

In particular:

- **Multimedia Principles:** guidelines of how to best use visuals, text and audio, but also guidelines for content segmenting and sequencing.
- **Principles for instructional methods and approaches:** guidelines for instructional methods such as use of examples, practice and feedback, collaboration facilities, navigation tools and problem solving techniques.

Multimedia Principles do not apply to content only; as we are going to see we should also apply the Multimedia Principles to the Instructional Methods alongside with each Instructional Method Principle. At the following sections we shall present these guidelines for each category, that is Multimedia Principles, Worked Example Principles, Practice Principles etc.

The adopted presentation format for each Principle includes a table that indicates fields such as:

- **A:** the main principle category, e.g. Multimedia Principles, Worked Example Principles etc.
- **B:** the Principle's name, e.g. The Coherence Principle
- **C:** the description, basis and necessary knowledge background
- **D:** the provided guidelines

Table 7: How the guidelines are presented and organized

MULTIMEDIA PRINCIPLES		A
1. The Coherence Principle		B
Description		
Basis		C
Background		
Guidelines		D

9.6.1 Multimedia Principles

According to Mayer and Clark (2011) there are eight Multimedia Principles, presented at Figure 66. These principles describe optimal ways to use, arrange, combine and present multimedia elements such as graphics, text and audio.

Figure 66: The Multimedia Principles

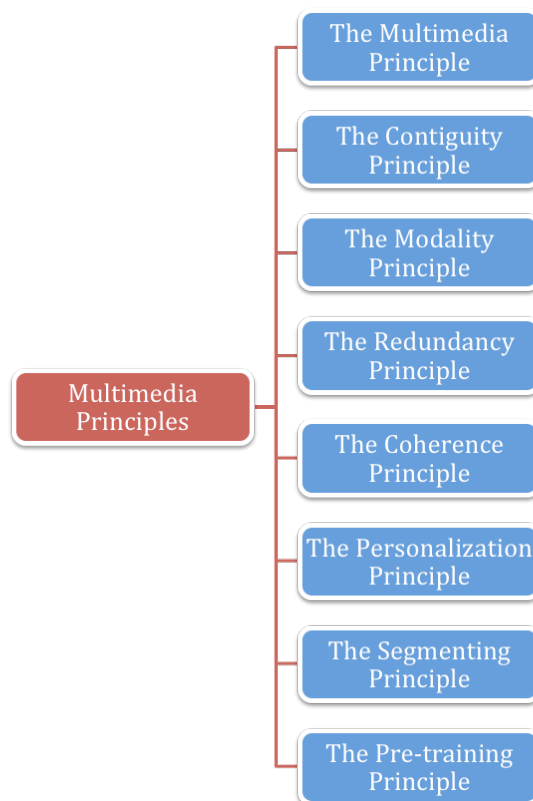

Each of the eight multimedia principles refers to the limitations of our cognitive system as well as to the processes that occur while learning takes place. Table 8 presents a short description of each multimedia principle and the corresponding cognitive principle.

Note that the psychological reason for the validity of the Personalisation Principle is social related and not cognitive as the rest of the Multimedia Principles. As the authors note, *social presence* refers to the extent to which a delivery medium (in our case a computer or a mobile device) can produce social cues such as face-to-face communication human interactions, including speech, body language, emotions, etc.

Table 8: The Multimedia Principles

Multimedia Principles		Description	Cognitive Principle
1	Multimedia Principle	Use words and graphics rather than words alone	Dual channels
2	Contiguity Principle	Align words to correspond to graphics	Limited capacity
3	Modality Principle	Present words as audio narration rather than on-screen text	Dual channels
4	Redundancy Principle	Explain visuals with words or text: not both	Dual channels
5	Coherence Principle	Adding extraneous material can hurt learning	Limited capacity
6	Personalisation Principle	Use conversational style and virtual coaches	(Social presence)
7	Segmenting Principle	Manage complexity by breaking a lesson into parts	Limited capacity
8	Pre-training Principle	Present key concepts prior to presenting the processes or procedures related to those concepts	Limited capacity

MULTIMEDIA PRINCIPLES	
1. The Multimedia Principle	
Description	People learn more deeply from words and relevant graphics than from words alone. Also called the <i>multimedia effect</i> .
Basis	(Mayer & Clark, 2011) Chapter 4
Background	<ul style="list-style-type: none"> ● <i>Decorative graphics</i>: Visuals used for aesthetic purposes or to add humor, such as a picture of a person riding a bicycle in a lesson on how bicycle pumps work. ● <i>Representational graphics</i>: Visuals used to show what an objective looks like, such as a computer screen or a piece of equipment. ● <i>Transformational graphics</i>: Visuals used to show changes in time or space such as a weather cycle diagram or an animated illustration of a computer procedure. ● <i>Relational graphics</i>: Visuals used to summarize quantitative relationships such as bar charts and pie graphs. ● <i>Interpretive graphics</i>: Visuals used to depict invisible or intangible relationships such as an animation of a bicycle pump that uses small dots to represent the flow of air. ● <i>Organizational graphics</i>: Visuals used to show qualitative relationships among lesson topics or concepts, for example, a tree diagram. ● <i>Expertise reversal effect</i>: Instructional methods that are helpful to novice learners may have no effect or even depress learning of high- knowledge learners.
Guidelines	<p>1.1 Use relevant graphics and text to communicate content.</p> <p>1.2 Minimize graphics that decorate the page (<i>decorative graphics</i>) or just represent a single object (<i>representational graphics</i>) and incorporate graphics that help the learner understand (<i>transformational, relational and interpretive graphics</i>) or organize the material (<i>organizational graphics</i>).</p> <p>1.3 Be sensitive to the level of prior knowledge of your learners; the multimedia principle works best for novices (<i>expertise reversal effect</i>).</p> <p>1.4 Use explanatory visuals that show relationships among content topics to built deeper understanding.</p> <p>1.5 Use static illustrations to avoid overloading the working memory of the learner, unless there is a compelling instructional reason for animation.</p> <p>1.6 Use relevant graphics explained by audio narration to communicate content (<i>Multimedia and Modality Principles</i>).</p>

1.7 Use animations to demonstrate procedures; use a series of stills to illustrate process (*Multimedia and Coherence Principles*).

MULTIMEDIA PRINCIPLES

2. The Contiguity Principle

Description People learn more deeply when corresponding printed words and graphics are placed close to one another on the screen or when spoken words and graphics are presented at the same time.

Basis (Mayer & Clark, 2011) Chapter 5

- Guidelines**
- 2.1** Integrate text nearby the graphic on the screen.
 - 2.2** Allow learners to play an animation before or after reviewing a text description.
 - 2.3** Avoid separation of text and graphics on scrolling screens.
 - 2.4** Avoid separation of feedback from questions or responses.
 - 2.5** Avoid separating lesson screens with linked windows.
 - 2.6** Avoid presenting exercise directions separate from the exercise.
 - 2.7** Avoid displaying captions at the bottom of screens.
 - 2.8** Avoid simultaneous display of animations and related text.
 - 2.9** Avoid using a legend to indicate the parts of a graphic.
 - 2.10** Avoid separation of graphics and narration through icons.
 - 2.11** Avoid separation of graphics and narration in a continuous presentation.
 - 2.12** Avoid covering or separating information that must be integrated for learning.

MULTIMEDIA PRINCIPLES

3. The Modality Principle

Description	People learn more deeply from multimedia lessons when graphics are explained by audio narration rather than onscreen text. Exceptions include situations when learners are familiar with the content, are not native speakers of the narration language, or when only printed words appear on the screen.
Basis	(Mayer & Clark, 2011) Chapter 6
Guidelines	3.1 Audio narrations must be brief and clear to be effective.
	3.2 Use audio narration instead of on-screen text whenever the graphic (animation, video, or series of static frames) is the focus of the words and both are presented simultaneously.
	3.3 Use audio narration instead of on-screen text when the visuals are relatively complex, and therefore using audio allows the learner to focus on the visual while listening to the explanation.
Exceptions	3.4 There are times when the words should remain available to the learner for memory support—particularly when the words are technical, unfamiliar, not in the learner’s native language, or needed for future reference. Maintain information as on-screen text to provide the learner the needed time for processing.
	3.5 In many cases it may not be practical to implement the modality principle, because the creation of sound may involve technical demands that the learning environment cannot meet (such as bandwidth, sound cards, headsets, and so on), or may create too much noise in the learning environment.
	3.6 Using sound may add unreasonable expense or may make it more difficult to update rapidly changing information.
	3.7 The recommendation is limited to those situations in which the words and graphics are simultaneously presented, and thus does not apply when words are presented without any concurrent picture or other visual input.
	3.8 When the learner is not a native speaker of the language of instruction or is extremely unfamiliar with the material, it may be appropriate to present printed text.
	3.9 If you present only printed words on the screen (without any corresponding graphic) then the modality principle does not apply.

MULTIMEDIA PRINCIPLES	
5. The Coherence Principle	
Description	Avoid extraneous audio, graphics, or graphic treatments and words to minimize irrelevant load imposed on memory during learning.
Basis	(Mayer & Clark, 2011) Chapter 8
Guidelines	5.1 Avoid e-lessons with extraneous audio: do not contain extraneous sounds in the form of background music or sounds.
	5.2 Avoid e-lessons with extraneous graphics: do not use illustrations, photos, and video clips that may be interesting but are not essential to the knowledge and skills to be learned.
	5.3 Use simpler visual illustrations such as line drawings when the goal is to help learners build understanding.
	5.4 Avoid e-lessons with extraneous or/and lengthy text/words: do not contain interesting stories or details that are not essential to the instructional goal
	5.5 Present the core content with the minimal amount of words and graphics needed to help the learner understand the main points.
	5.6 Use animations to demonstrate procedures; use a series of stills to illustrate process (<i>Multimedia and Coherence Principles</i>).

MULTIMEDIA PRINCIPLES	
7. The Segmenting Principle	
Description	People learn more deeply when content is broken into small chunks and learners can control the rate at which they access the chunks. A good strategy for managing complex content that imposes considerable essential processing.
Basis	(Mayer & Clark, 2011) Chapter 10
Guidelines	7.1 Present material in manageable segments (such as short clips of narrated animation) controlled by the learner by using a continue or next button, rather than as a continuous unit (such as a long clip of narrated animation).
	7.2 Pause animation sequences at logical segments with provision of a replay or continue button.

MULTIMEDIA PRINCIPLES	
8. The Pre-training Principle	
Description	People learn more deeply when lessons present key concepts prior to presenting the processes or procedures related to those concepts.
Basis	(Mayer & Clark, 2011) Chapter 10
Guidelines	8.1 Name key concepts and describe their characteristics before presenting the processes or procedures to which the concepts are linked.
	8.2 When teaching concepts and facts prior to procedures or processes, maintain the context of the procedure or process.

9.6.2 Simulations and Games Principles

Although during the last years simulations and games are one of the hottest topics in e-learning we do not have yet a clear picture of how to best design and embed interactions of this type in e-learning courses (Mayer & Clark, 2011). Recent research (Mayer, 2011) has provide us with some useful guidelines, categorised as follows:

- Principle 1: *Match game types to learning goals*
- Principle 2: *Make learning essential to game progress*
- Principle 3: *Build in proven instructional strategies*
- Principle 4: *Build in guidance and structure*
- Principle 5: *Manage complexity*
- Principle 6: *Make relevance salient*

SIMULATIONS AND GAMES PRINCIPLES	
9. Principle 1: Match game types to learning goals	
Description	Depending on the required skills that you want to foster, choose a specific game type.
Basis	(Mayer & Clark, 2011) Chapter 16
Guidelines	9.1 For cognitive learning outcomes, games with time goals that require fast responses are not a good match. However, rapid response games may be well suited for skills that must become automated through extensive drill and practice.

<i>SIMULATIONS AND GAMES PRINCIPLES</i>	
<i>10. Principle 2: Make learning essential to game progress</i>	
Description	Require from your learners relevant to learning knowledge/skills during the game progress.
Basis	(Mayer & Clark, 2011) Chapter 16
Guidelines	10.1 Ensure that game progress and success translate into learning. In other words, the learning required to succeed in a game should be the same learning required by your instructional objectives.

<i>SIMULATIONS AND GAMES PRINCIPLES</i>	
<i>11. Principle 3: Build in proven instructional strategies</i>	
Description	Integrate proven guidelines into games and simulations in ways that maintain their motivational benefits.
Basis	(Mayer & Clark, 2011) Chapter 16
Guidelines	11.1 Incorporate explanatory feedback.
	11.2 Add self-explanation questions.

<i>SIMULATIONS AND GAMES PRINCIPLES</i>	
<i>12. Principle 4: Build in guidance and structure</i>	
Description	Techniques for guidance and structure.
Basis	(Mayer & Clark, 2011) Chapter 16, (De Jong, 2011)
Background	<ul style="list-style-type: none"> ● <i>Discovery Learning</i>: Experiential exploratory instructional interfaces that offer little structure or guidance. ● <i>Inquiry Simulation</i>: An online simulation designed specifically to teach skills of the scientific method such as identifying hypotheses, setting up experiments to test hypotheses, etc.
Guidelines	12.1 Avoid discovery learning: Avoid open-ended games and simulations that require unguided exploration (<i>Guidance Principle</i>).

	<p>12.2 Design guidance appropriate for inquiry simulations:</p> <ul style="list-style-type: none"> ● help learners identify relevant variables ● provide hypotheses in a “ready-made” manner such as in a menu rather than asking learners to derive hypotheses on their own ● offer a domain-specific structure for the inquiry process through a set of concrete assignments ● require learners to reflect on their activities and the results of their activities.
	<p>12.3 Incorporate visualization support: Success in some simulations or games may rely on spatial skills. For these types of games, instructional aids can promote learning by providing external spatial representations as guides.</p>
	<p>12.4 Incorporate instructional explanations as:</p> <ul style="list-style-type: none"> ● feedback to learner responses ● hints appearing between simulation rounds

<i>SIMULATIONS AND GAMES PRINCIPLES</i>	
<i>13. Principle 5: Manage complexity</i>	
Description	Manage cognitive overload due to interface design complexity.
Basis	(Mayer & Clark, 2011) Chapter 16, (Carroll, 2000)
Background	<ul style="list-style-type: none"> ● <i>Training Wheels</i>: A technique introduced by John Carroll in which learners work with software simulations that are initially of limited functionality and progress to higher fidelity simulations as they master lower-level skills.
Guidelines	<p>13.1 Move from simple to complex goals: Begin a game or simulation with a relatively low challenge task or goal and move gradually to more complex environments.</p>
	<p>13.2 Provide training wheels.</p>
	<p>13.3 Align pace to instructional goals: Games that rely on rapid responses to win may benefit learning of skills that require responses based on speed and accuracy. If your instructional goals require application of concepts and rules, games that proceed under learner control of pacing and do not reward speed will be more effective.</p>
	<p>13.4 Ensure ease of use:</p> <ul style="list-style-type: none"> ● make the interface user-friendly with techniques such as providing a checklist rather than requiring typing ● embedded help that explains how the game or simulation works and/or provides domain-specific background knowledge.

	13.5 Adapt complexity to learner expertise: Learners with minimal background benefit more from simple games/simulation.
--	--

SIMULATIONS AND GAMES PRINCIPLES

14. Principle 6: Make relevance salient

Description	Consider the context and genre of the game or simulation to ensure that its relevance to job roles is immediately clear.
Basis	(Mayer & Clark, 2011) Chapter 16
Guidelines	14.1 Design interface and activities to make the relevance of the activity salient.

10. Antikythera Mechanism models

Since the Antikythera Mechanism was discovered in the 1900's many researchers have manufactured solid models of this strange artifact (see Table 9). Although some of them were not operational, they were initially developed as representational tools for understanding the mechanism's complex structure and evaluating current reconstructions.

Manos Roumeliotis (2012) offers us a taxonomy of models, according to the following diagram:

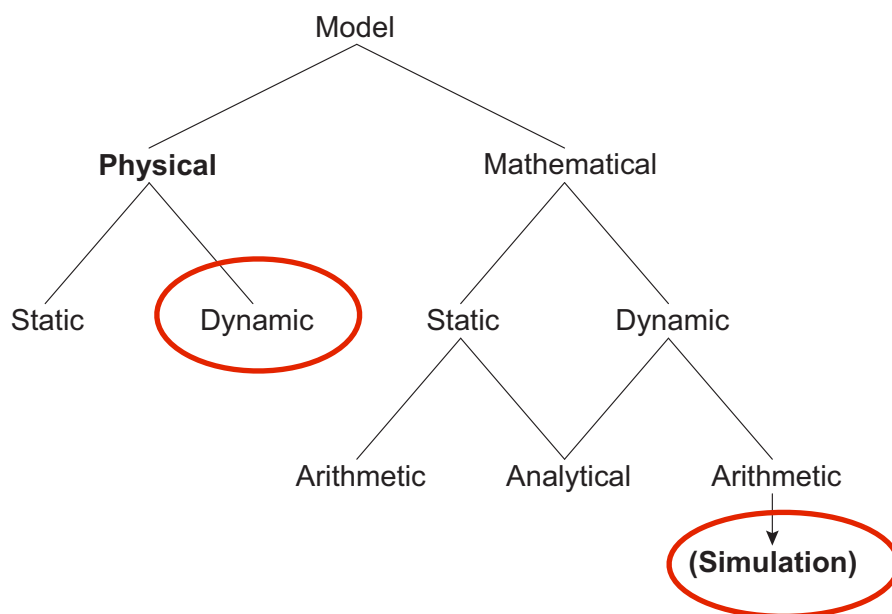

Fig.67: Classification of models (adapted from Roumeliotis, 2012)



For our purposes we are interested into two categories that both reside at the lower right part of the tree diagram: physical (dynamic) models and simulation models (although this classification follows a more Computer Science approach we adopt the earlier mentioned classification of simulations by Alessi and Trollip, 2001)



10.1 Physical Models

Table 9 presents some of the solid models manufactured so far. It indicates their creator, year of construction, the based schema and a picture if available. The first know working physical model was constructed by John Theophanidis as part of his research and was capable of displaying the movement of some planets (Moussas, 2012). Although implied before, it is wise to clearly state that for our purposes we are

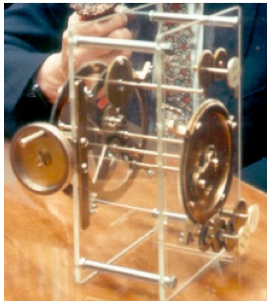
interested only for working physical models. Figures 68-71 present some working models used in exhibitions.

Table 9: Antikythera Mechanism solid models

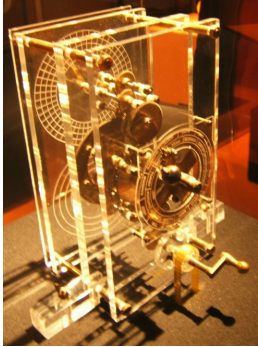
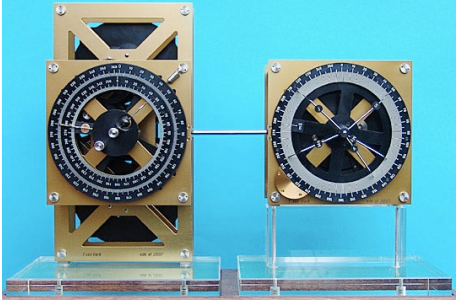
Dating	Constructed by	Based on	Picture
1930's	John Theofanidis	personal model	
1980's	Robert Deroski	Derek Pice	
1990s	Frank Percival and Allan Bromley	Allan Bromley and Michael Wright	
2002-2013	Michael Wright	personal model	

Dating	Constructed by	Based on	Picture
1999-2013	Dionysios Kriaris	AMRP	
2007-2013	Massimo Vicentini	personal model	
2008	Tatjana van Vark	personal model	
2008-2013	John H. Seiradakis and Kyriakos Efstathiou	AMRP	

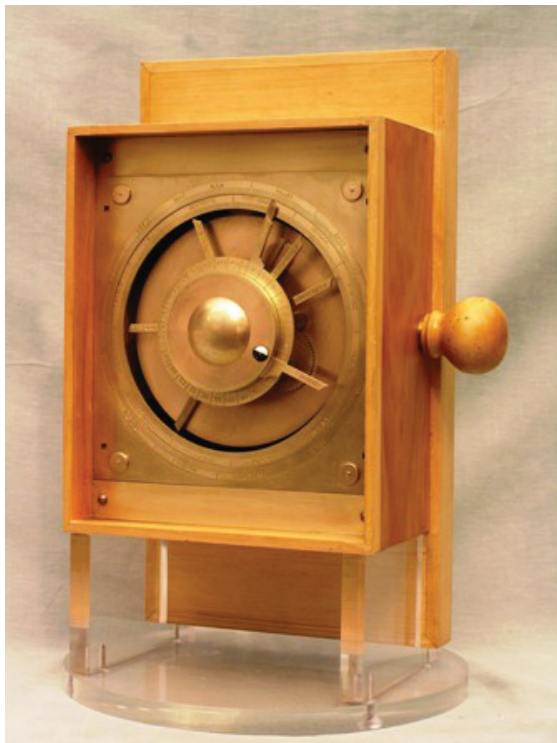

Fig.68: . Michael Wright's physical model based on his own schema.



Fig.69: Dionysios Kriaris's physical model based on the AMRP schema

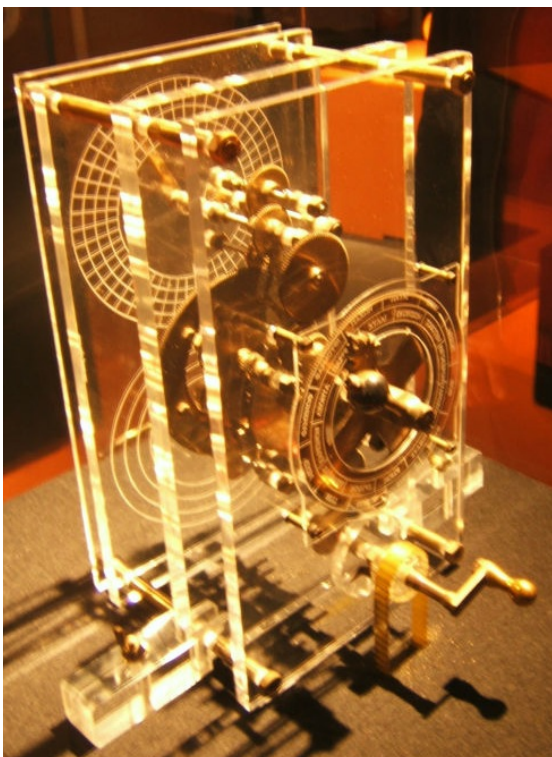

Fig.70: Massimo Vicentini's physical model based on his own schema.



Fig.71: John Seiradakis and Kyriakos Efstathiou's physical model based on the AMRP schema.

10.2 Simulation Models

Although physical models were developed almost simultaneously as scholars were researching the mechanism, simulations (computer models) had to wait until the development of necessary hardware and software. The first computer model was designed by Robert Morris during the 1980's but is far away from what we conceive as simulation today, since the graphic user interface (GUI) was still not part of the user-system interaction. The majority of the developed computer models were primarily designed as tools for researchers: Roumeliotis (2012) notes that simulations increased the awareness of the mechanism and the number of engaged scholars.

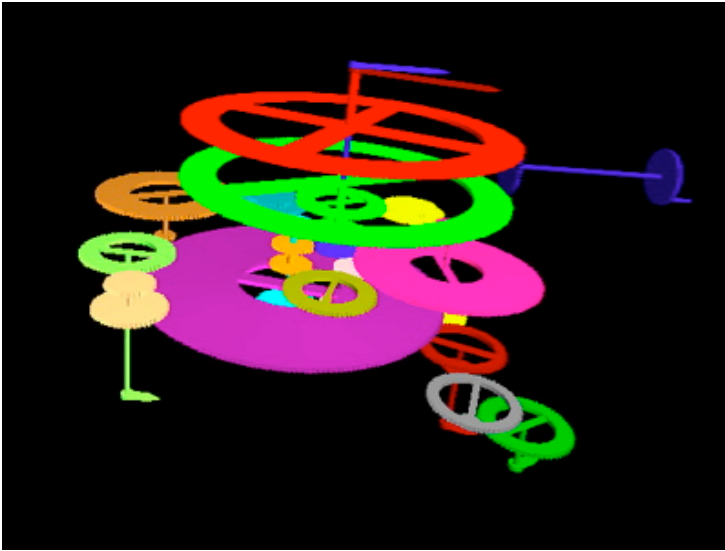

Fig.65: [Manos Roumeliotis's simulation](#). Freely distributed only for Windows OS. It has two separate versions for Price and AMRP's models.

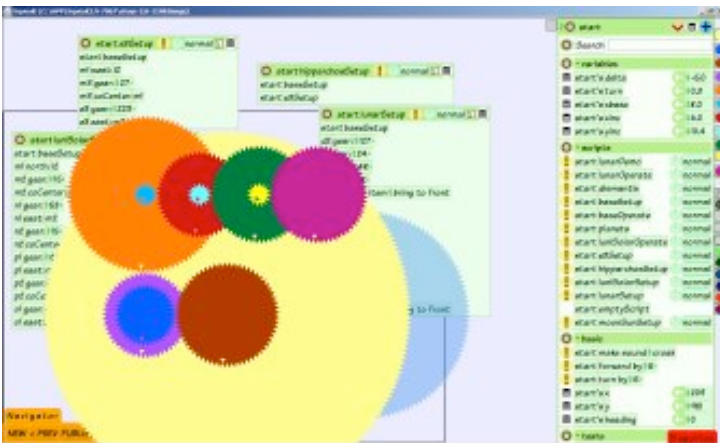

Fig.66: [Diomidis Spinellis's emulation](#). Freely distributed for Windows, Macintosh and Linux OS with Etoys platform. It is partially based on the AMRP's model.

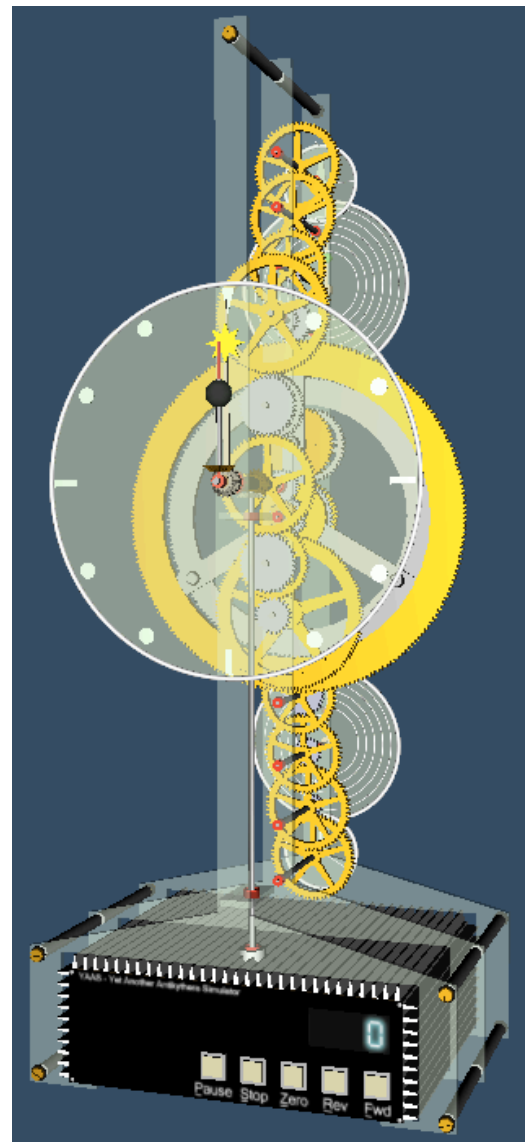

Fig.67: [Olaf V's simulation](#). Freely distributed for Windows, Macintosh and Linux OS as a web browser plug-in or as a standalone application. Personal model.

Antikythera Mechanism

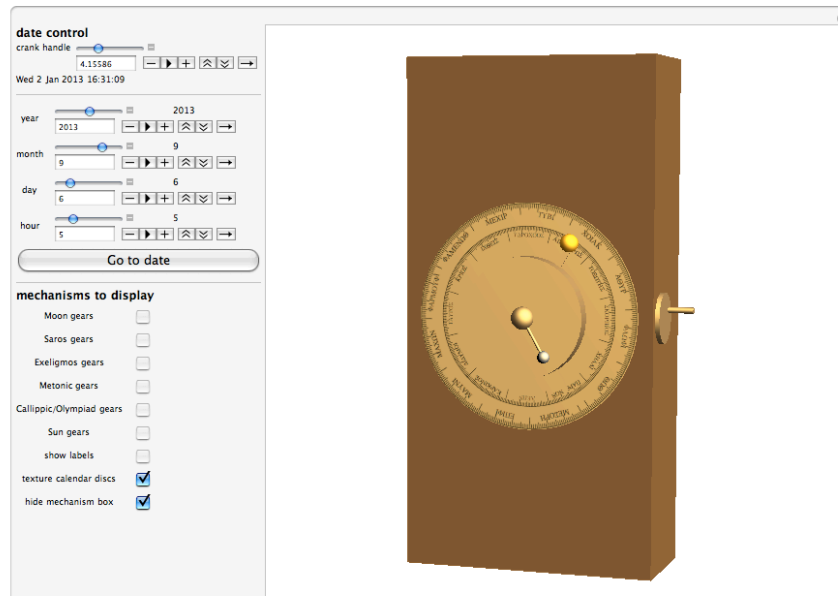

Fig.68: [Adam Goucher's simulation](#). Freely distributed for Windows, Macintosh and Linux OS as a web browser plug-in or as a standalone application. It is based on the AMRP's model.

10.3 Comparing Physical and Computer Models

We believe that there is no prerequisite knowledge needed in order to identify the benefits of computer models (simulations) in comparison with physical ones. Of course there are situations where a physical model is necessary but in our case using an Antikythera Mechanism physical model complicates things a little furthermore since our understanding about the mechanism is constantly changing. Thus constantly constructing a physical model and adapting it to our current understanding is not trivial, not to mention difficulties related to practical aspects, such as craftsmanship skills and budget costs. Moreover a physical model is limited in terms of collaboration since its small size requires an equally small amount of learners interacting with it. Finally a physical model cannot be widely distributed and used for educational purposes. For example, a successful exhibition of an Antikythera Mechanism physical model (Moussas et al., 2009) took over 3 years for achieving about half a million of visitors while a downloadable educational application could have achieved over a billion of downloads at the same time. In addition, Roumeliotis (2012) has shown that some of the advantages that simulations have over physical models are:

- 1) the verification of estimated parameters
- 2) the validation of hypotheses about the mechanism's design
- 3) promoting widespread awareness about the mechanism

Note that our intention is not to argue in favor of one type model against the other; we believe that each model has different benefits and potential. A more pedagogical approach could probably consist of a combination of the two model types. Nevertheless our scope is to show that the educational potential of the Antikythera Mechanism's computer models is not yet fully exploited.

11. Educational Potential

The Antikythera Mechanism can be both considered as a technological achievement and a “time capsule” enabling scholars to deduce the scientific knowledge and craftsmanship of its era. Names like ‘an ancient computer’ or ‘a 2,000 years old computer’ are common characterizations and increase the “enchancing powers” that the mechanism possesses. The mechanism is a great “attractor” of children to Science, Mathematics, Technology and Philosophy and exhibitions around the world under the theme *Antikythera Mechanism, the first computer* curated by Xenophon Moussas and colleagues have been very successful (Moussas et al., 2009): from 2007 to 2010 more than half a million people visited the exhibition (see Table 10).

Event	Place	Date	Visitors
National touring exhibition	Hellenic Museum, Chicago, USA	2010	
<i>Gods, Myths and Mortals: Discover Ancient Greece</i> , Children’s Museum of Manhattan	New York, USA	2007–2010	500,000
Aurora Polaris, Grundtvig	Olsztyn Planetarium, Poland	May-Sep 2009	10,000
University of Patras Center	Patras, Greece	Mar 2009	2,000
Culture Center City of Rehtymnon	Rehtymnon, Greece	27-30 Mar 2009	300
Museum Gustavianum, Uppsala	Uppsala, Sweden	31 Jan-29 Apr 2009	10,000
Inauguration of IYA 2009 + IAU Symposium 260	UNESCO, Paris, France	15-23 Jan 2009	2,500
Planetarium Science Center Bibliotheca Alexandrina exploratorium	Alexandria, Egypt	1-30 Nov 2008	2,000
Zappeion, Research and Innovation exposition	Athens, Greece	Nov 2008	3,000
Abet Greek School in Cairo	Cairo, Egypt	29 Nov 2008	300
Exhibition at CRAAG	Algiers Observatory, Algeria	2 Nov 2008	50
7ème Salon d’Astronomie	Constantine, Algeria	30 Oct-1 Nov 2008	6,000
Ionic Centre	Athens, Greece	22 Oct-14 Dec 2008	7,000
HELEXPO/DETH Intl Fair	Thessaloniki, Greece	Sep 2008	4,000
Aurora Polaris, Grundtvig	Athens, Greece	Sep 2008	30
Church Children Camp N. Makri	Alexandroupolis, Greece	1 Aug 2008	140
Amphitheatre of Gymnasium	Kasos, Greece	30 Jul 2008	300
Karditsa Cultural Center	Karditsa, Greece	28 Feb 2008	300
City of Chios	Chios, Greece	9 Feb 2008	200
City of Ermioni	Ermioni, Greece	Feb 2008	120
HELEXPO/DETH Intl Fair	Thessaloniki, Greece	Sep 2007	4,000
Municipal Theatre	Alexandroupolis, Greece	5 May 2007	180
Zappeion, Research and Innovation exposition	Athens, Greece	May 2007	3,000

Table 10: Exhibitions of the Antikythera Mechanism around the world (Moussas et al., 2009)

Moreover, the Antikythera Mechanism encapsulates the notion that ancient Greeks held about science: it was treated as “one” without the modern boundaries between academic subjects. Such an interdisciplinary object may encourage/motivate the study of the following fields (Moussas, 2011):

1. **Astronomy:** as a representation tool, as a cue for connecting Astronomy with Mathematics and Physics.
2. **Mathematics and Physics.**
3. **Mechanical engineering:** how is possible to cut so small gears with tiny teeth and then assemble them into one device?

4. **Metallurgy and Chemistry:** chemical composition, why and how the maker made harder then gear teeth than the gear body, why using lead as a chemical component (as a self lubricant).
5. **The Mechanism's history and History of Greece, of Mathematics.**
6. **Geography.**
7. **Study of ancient texts.**
8. **Philosophy and History of Science:** as a paradigm for the evolution of scientific ideas related to our understanding of Cosmos.

11.1 Mathematics Education

The encapsulated knowledge in the Antikythera Mechanism can be probably used in many ways in Mathematics Education. Elias Gourtsoyannis (2006) inspired from the mechanism had proposed some projects suitable for schools which require no more than secondary school Maths.

Project 1: A craftsman/engineer is required to cut N teeth in the shape of equilateral triangles on the rim of a wheel of radius r by using a 60° file edge. Assume that the final configuration will consist of a regular polygon with N sides, each side forming the base of a triangular “tooth” as shown in the diagram below:

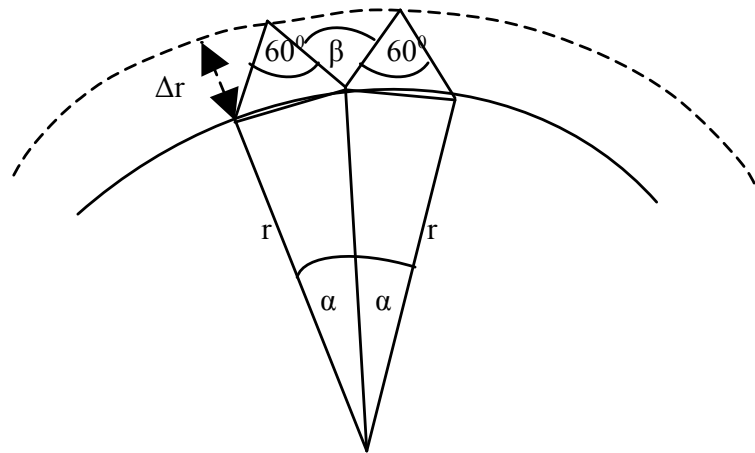

Fig.69: The “cutting teeth” problem (Gourtsoyannis, 2006)

Questions:

1. Find an approximate formula which provides a value for the depth of cut Δr , in terms of r , the radius of the wheel and N , the number of teeth of the wheel.
2. Find an exact formula which provides a value for the depth of cut Δr in terms of r , the radius of the wheel and N , the number of teeth of the wheel.
3. In the Antikythera Mechanism, one of the wheels has a diameter of 132mm and carries 223 teeth. Use your approximate and exact formulae to calculate the depth of cut Δr in both cases. Find the percentage error. Repeat these calculations for wheel diameters of (i) 18mm and 24 teeth and (ii) 60mm and 72 teeth.

Solution:

1. Approximate method

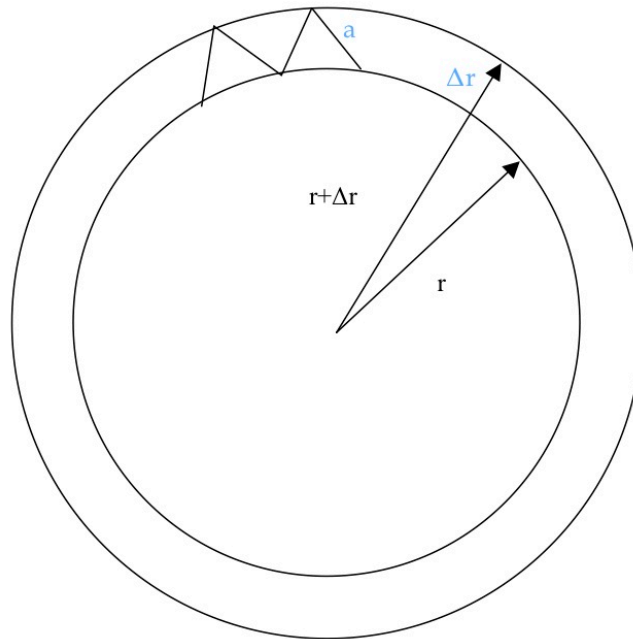

Fig.70: The “cutting teeth” problem (approximate method)

Let a be the side of the equilateral triangle. Then

$$\Delta r = \frac{a\sqrt{3}}{2}$$

and if N is the number of the teeth on the wheel then

$$N = \frac{2\pi r}{a} \quad (1)$$

Thus we have

$$N = \frac{\pi r\sqrt{3}}{\Delta r} \quad (2)$$

and

$$\Delta r = \frac{\pi r \sqrt{3}}{N} \quad (3)$$

2. Exact method

Now let us consider a regular polygon of N sides . Each side is to form the base of a “tooth” in the shape of an equilateral triangle.

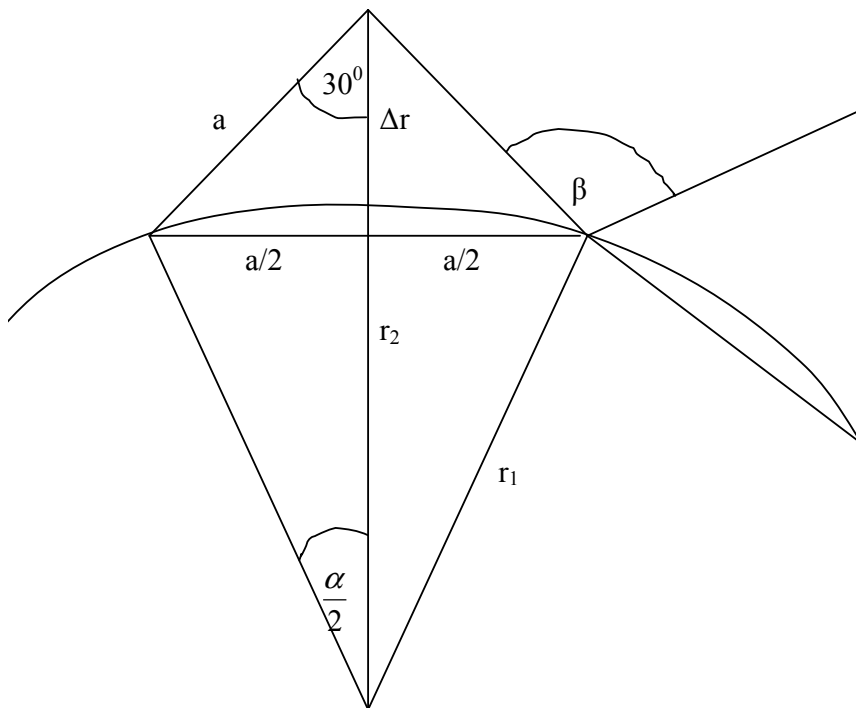

Fig.71: The “cutting teeth” problem (exact method) (Gourtsoyannis, 2006)

If α is the angle at the centre, then

$$\alpha = \frac{360}{N} \quad (4)$$

If a is the length of the side of the “tooth” (the side of the equilateral triangle), then

$$a = 2r_1 \sin \frac{\alpha}{2} \quad (5)$$

We have

$$r_2 = r_1 \cos \frac{\alpha}{2} + a \frac{\sqrt{3}}{2} = r_1 \cos \frac{\alpha}{2} + r_1 \sqrt{3} \sin \frac{a}{2}$$

Hence

$$r_2 = r_1 \left(\cos \frac{\alpha}{2} + r_1 \sqrt{3} \sin \frac{a}{2} \right) \Rightarrow r_2 = 2r_1 \sin \left(\frac{\alpha}{2} + 30^\circ \right) \quad (6)$$

where the form

$$a \cos \theta + b \sin \theta = R \sin(\theta + \delta)$$

was used, with R and δ constants to be determined. In particular

$$R = \sqrt{a^2 + b^2}$$

and δ is the angle for the point on the unit circle with coordinates (b/r, a/r) so that

$$\tan \delta = \frac{a}{b}$$

Thus

$$r_2 - r_1 = r_1 \left[2 \sin \left(\frac{\alpha}{2} + 30^\circ \right) - 1 \right]$$

and hence

$$\Delta r = r \left[2 \sin \left(\frac{\alpha}{2} + 30^\circ \right) - 1 \right] \quad (7)$$

Finally (4),(7) \Rightarrow

$$\boxed{\Delta r = r \left[2 \sin \left(\frac{180^\circ}{N} + 30^\circ \right) - 1 \right]} \quad (8)$$

3. Calculations

By using formulas (3) and (8) we obtain the following table:

Dimensions of wheel and no of teeth	r=9mm, N=24	r=30mm, N=72	r=66mm, N=223
Approximate Δr	2.041mm	2.267mm	1.663mm
Exact Δr	1.958mm	2.238mm	1.656mm
Error	4.1%	1.3%	0.4%

Project 2: One of the crucial ratios in the Antikythera Mechanism is the Metonic ratio 254/19. This is a good rational approximation to the decimal 13.36874... which represents the ratio of: **duration of sidereal year/duration of sidereal month** (The error in the approximation above is less than 1 part in 41,000). A useful exercise is to show how to arrive at the Metonic ratio 254/19 from the decimal 13.36874... by the use of continued fractions.

Solution: The algorithm is as follows:

We write

$$13.36874 = \frac{1336874}{100000}$$

Now,

$$1336874 = 13 \times 100000 + 36874$$

$$100000 = 2 \times 36874 + 26252$$

$$36874 = 1 \times 26252 + 10622$$

$$26252 = 2 \times 10622 + 5008$$

$$10622 = 2 \times 5008 + 606$$

$$5008 = 8 \times 606 + 160$$

$$606 = 3 \times 160 + 126$$

$$160 = 1 \times 126 + 34$$

$$126 = 3 \times 34 + 24$$

$$34 = 1 \times 24 + 10$$

$$24 = 2 \times 10 + 4$$

$$10 = 2 \times 4 + 2$$

$$4 = 2 \times 2 + 0$$

A convenient way of expressing a continued fraction is by using the notation

$$[13;2,1,2,2,8,3,1,3,1,2,2,2]$$

which stands for

$$13 + \frac{1}{2 + \frac{1}{1 + \frac{1}{2 + \frac{1}{2 + \frac{1}{8 + \frac{1}{3 + \frac{1}{1 + \frac{1}{3 + \frac{1}{1 + \frac{1}{2 + \dots}}}}}}}}}}}}$$

If we truncate the expansion to

$$[13;2,1,2,2]$$

we obtain the Metonic ratio 254/19.

The next convergent is given by

$$[13;2,1,2,2,8]$$

which works out as 2139/160 (the error is smaller than 1 over 1,300,000).

Project 3: How did Meton possibly arrive at the approximation 254/19?

Solution: By looking at the NASA Eclipse homepage¹⁶ (which is presumably the modern equivalent of Babylonian records, we note the number of new moons in the years from 1863 to 2127. With the benefit of hindsight (that the cycle is a 19-year one) we make a table as follows:

¹⁶ <http://eclipse.gsfc.nasa.gov/phase/phasecat.html>

1863	12	13	12	12	13	12	12	13	12	13	12	12	13	12	12	13	12	13	12
1882	12	13	12	12	13	12	12	13	12	13	12	12	13	12	12	13	12	12	13
1901	12	13	12	12	13	12	12	13	12	13	12	12	13	12	12	13	12	12	13
1920	12	13	12	12	13	12	12	13	12	13	12	12	13	12	12	13	12	12	13
1939	12	13	12	12	13	12	12	13	12	13	12	12	13	12	12	13	12	12	13
1958	12	13	12	12	13	12	12	13	12	13	12	12	13	12	12	13	12	12	13
1977	12	13	12	12	13	12	12	13	12	13	12	12	13	12	12	13	12	12	13
1996	12	13	12	12	13	12	12	13	12	13	12	12	13	12	12	13	12	12	13
2015	12	13	12	12	13	12	12	13	12	13	12	12	13	12	12	13	12	12	13
2034	12	13	12	12	13	12	12	13	12	13	12	12	13	12	12	13	12	12	13
2052	13	12	13	12	12	13	12	12	13	12	13	12	12	13	12	12	13	12	12
2071	13	12	13	12	12	13	12	12	13	12	13	12	12	13	12	12	13	12	13
2090	12	12	13	12	12	13	12	12	13	12	13	12	12	13	12	12	13	12	12
2109	13	12	13	12	12	13	12	12	13	12	12	13	12	13	12	12	13	12	12

The first column of the table represents the years (starting from 1863) and the rest 19 columns are representing the 19 years. Each cell contains the numbers of full moon for each year (12 or 13). As can be seen from the table, the only discrepancies (cells marked with gray color) in exact periodicity occur in the years 1880-1881 and 2052 onwards. However, the total number of new moons in any of the 19-year cycles from 1863 to 2070 is 235. Hence the Metonic ratio can be determined, without resource to sophisticated methods:

$$\frac{235}{19} + 1 = \frac{254}{19}$$

12. Are current simulations proper for educational purposes?

Our short analysis so far has clearly demonstrated that the Antikythera Mechanism indeed holds educational potential that can be exploited in many fields and ways. For reasons previously stated the use of software that simulates the Antikythera Mechanism is preferable but a natural question arises; *are current simulations proper for educational purposes?* In order to answer to this question, we followed the simple process described at Fig.72; first we examined if the simulations were designed with respect to the suggested guidelines, then we identified which metaphor of learning is adopted and finally we recognized the embedded instruction phases. Of course the proposed by Mayer and Clark (2011) guidelines are derived from the knowledge construction metaphor of learning but by identifying which metaphor the designer adopts is useful for

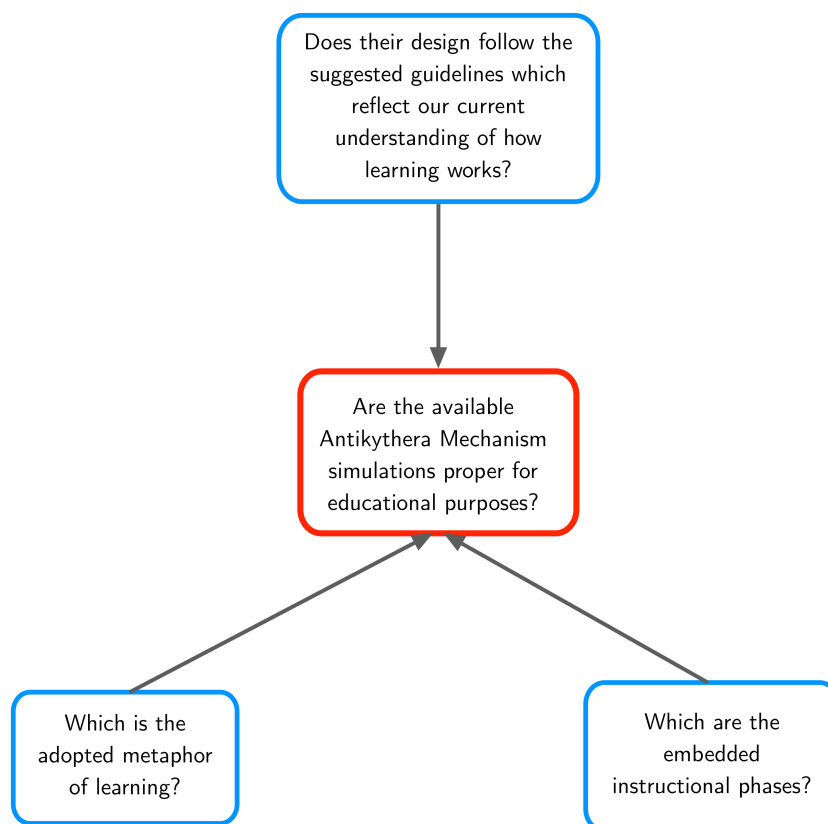

Fig.72: The process for answering our main question

applying our assumption about the instruction phases that an educational software encapsulates (section 9.3). However, it is useful to state here that our aim is not to evaluate the developed software but to demonstrate that these simulations need furthermore additions in order to be used (more efficiently) in education. Finally we would like to note that we examined only the e-learning simulations, that is simulations for use at a desktop computer only, since "mobility" complicates things furthermore (context of use, screen limitations etc).

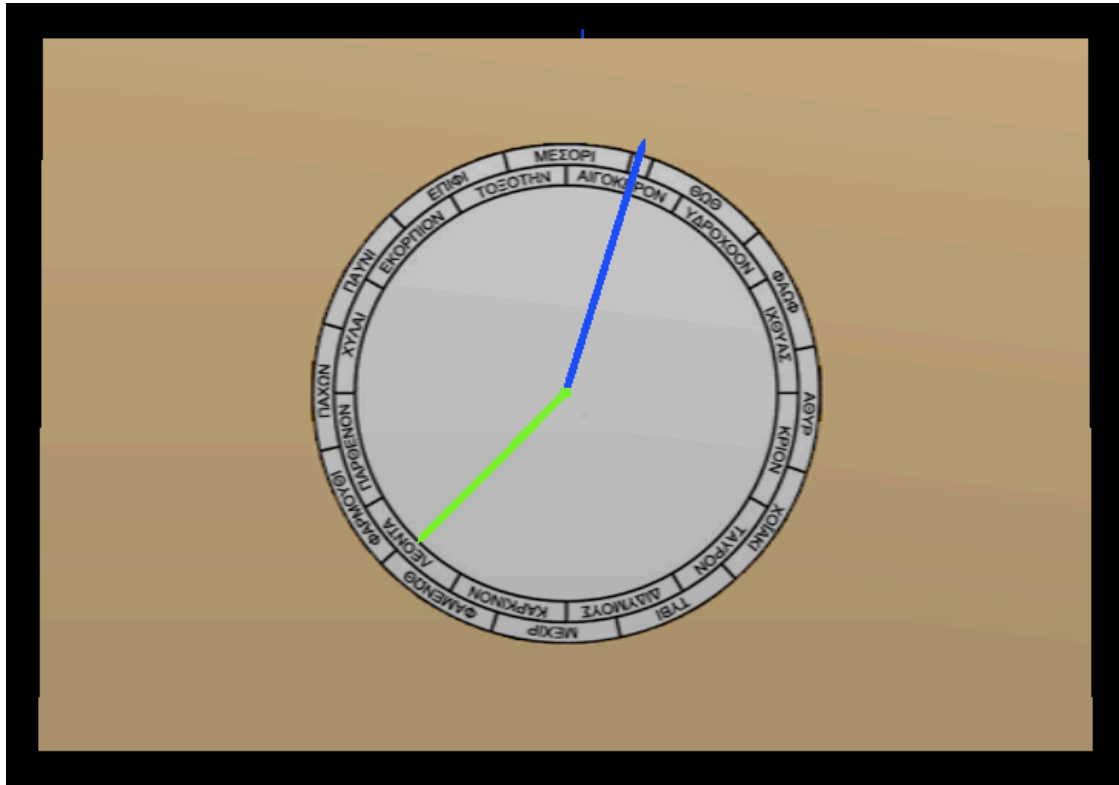

Fig.73: [Manos Roumeliotis's simulation](#). (Front view)

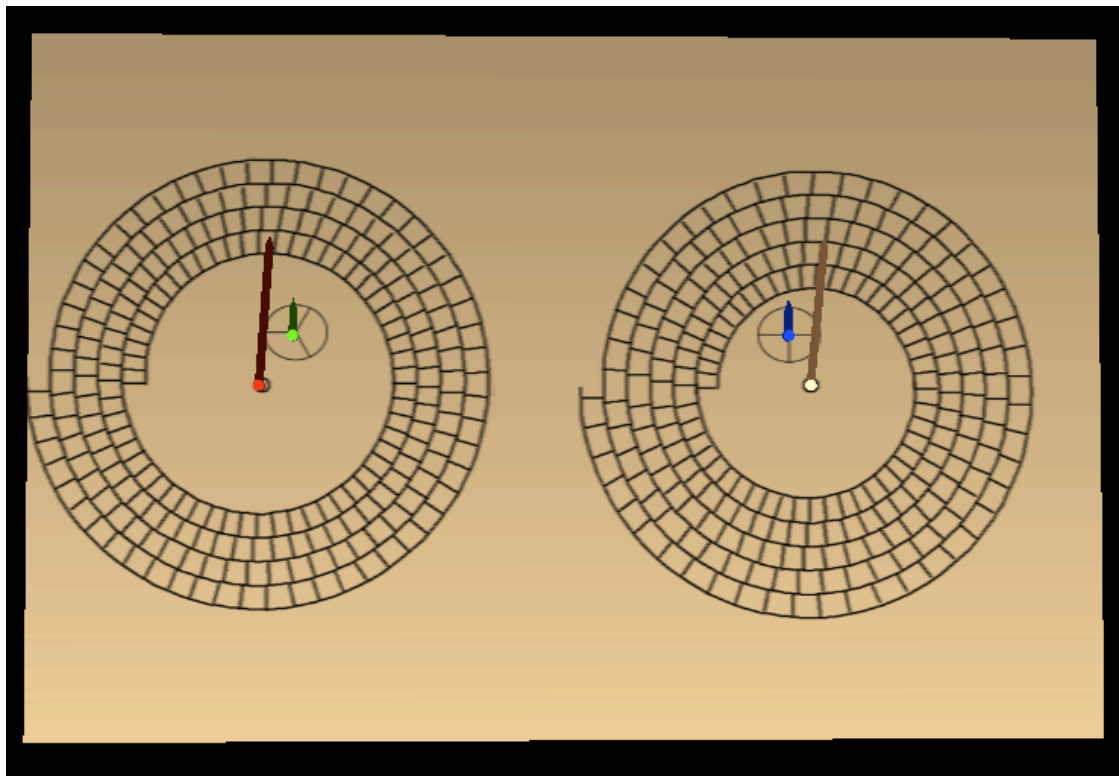

Fig.74: [Manos Roumeliotis's simulation](#). (Back view)

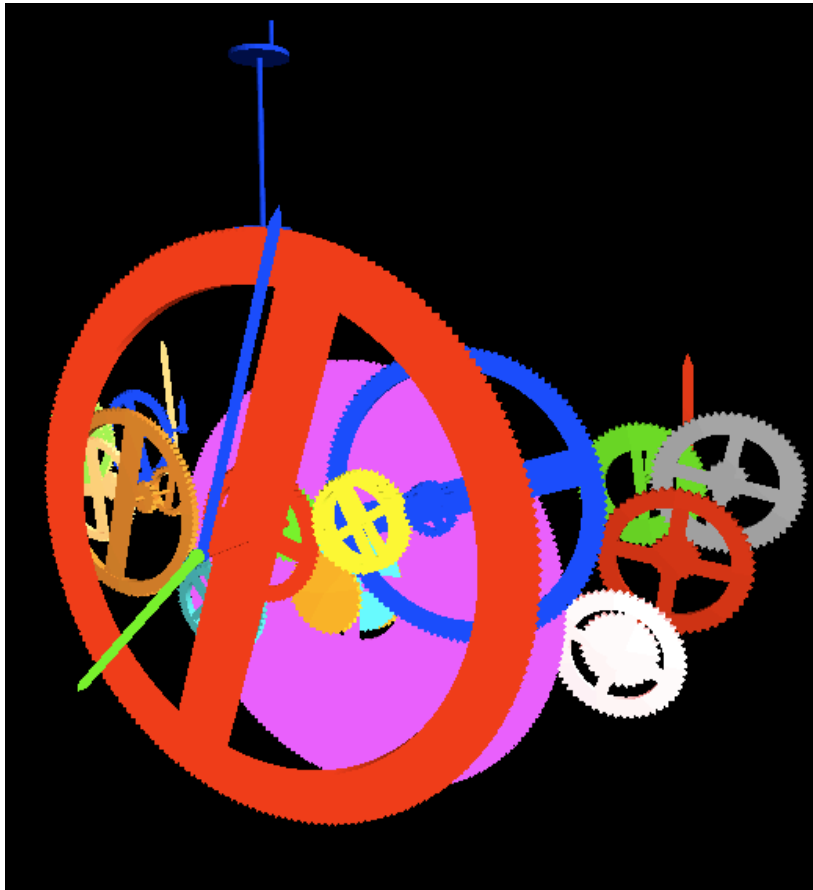

Fig.75: [Manos Roumeliotis's simulation](#). (Front view/no plates)

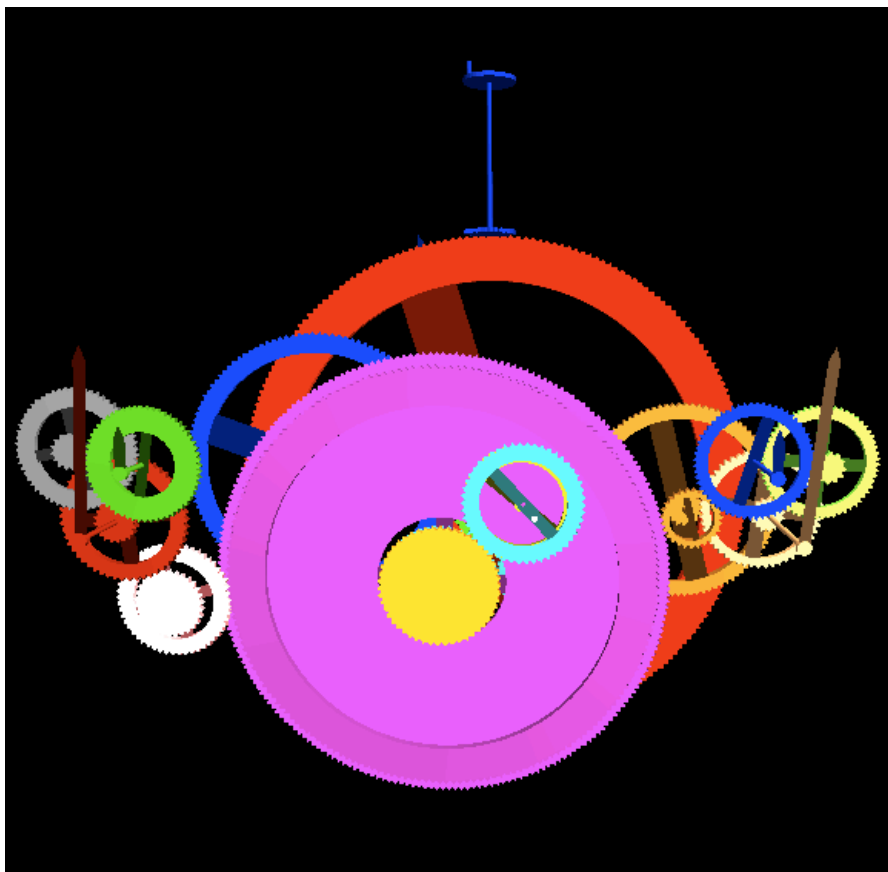

Fig.76: [Manos Roumeliotis's simulation](#). (Back view/no plates)

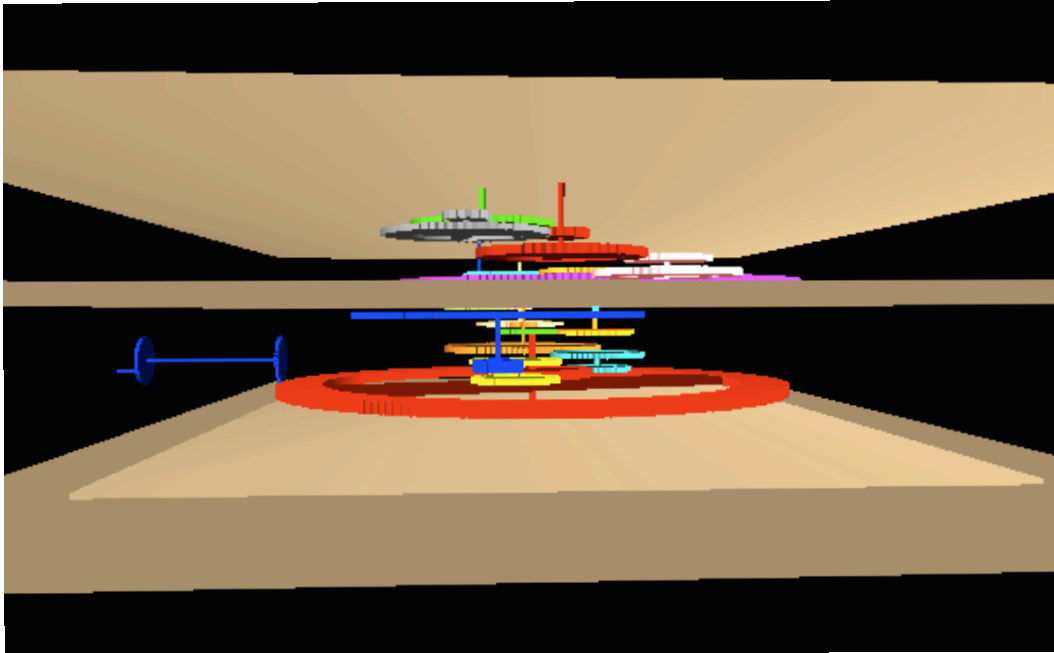

Fig.77: [Manos Roumeliotis's simulation](#). (Side view)

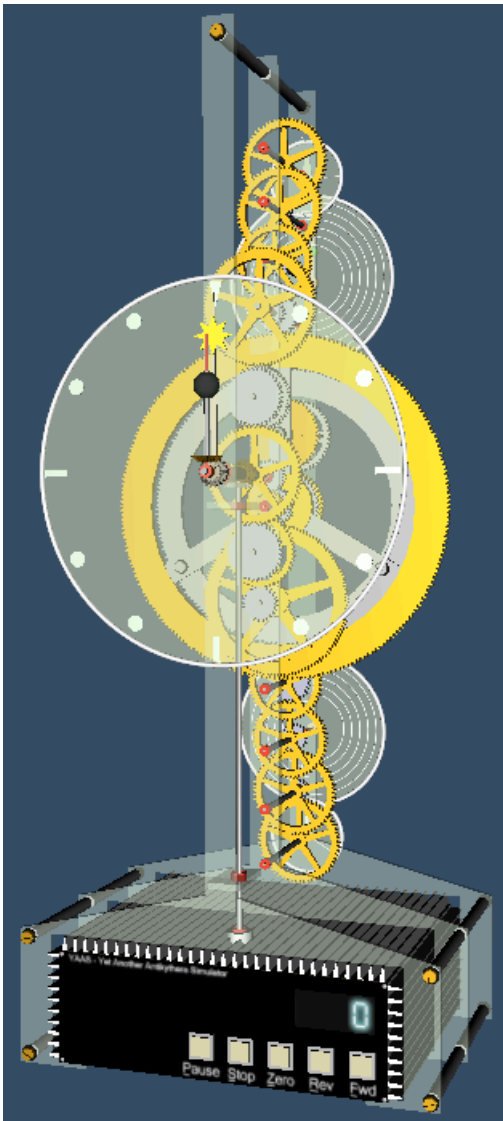

Fig.78: [Olaf V's simulation](#). (Front view)

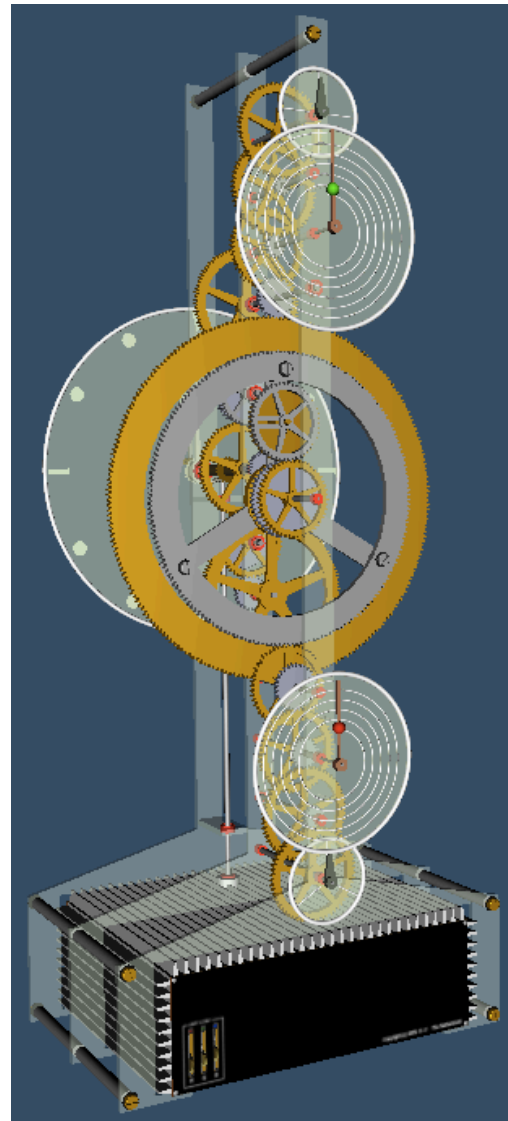

Fig.79: [Olaf V's simulation](#). (Back view)

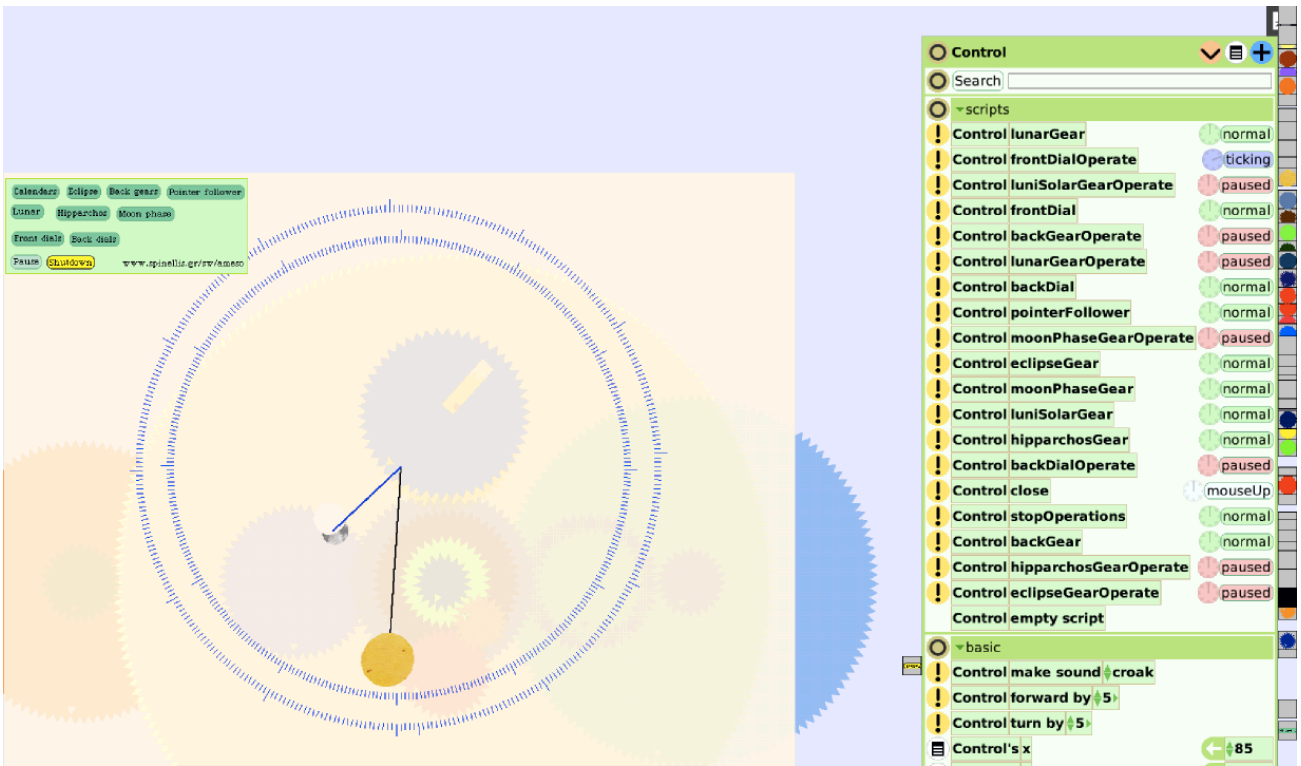

Fig.80: [Diomidis Spinellis's emulation](#). (Front view)

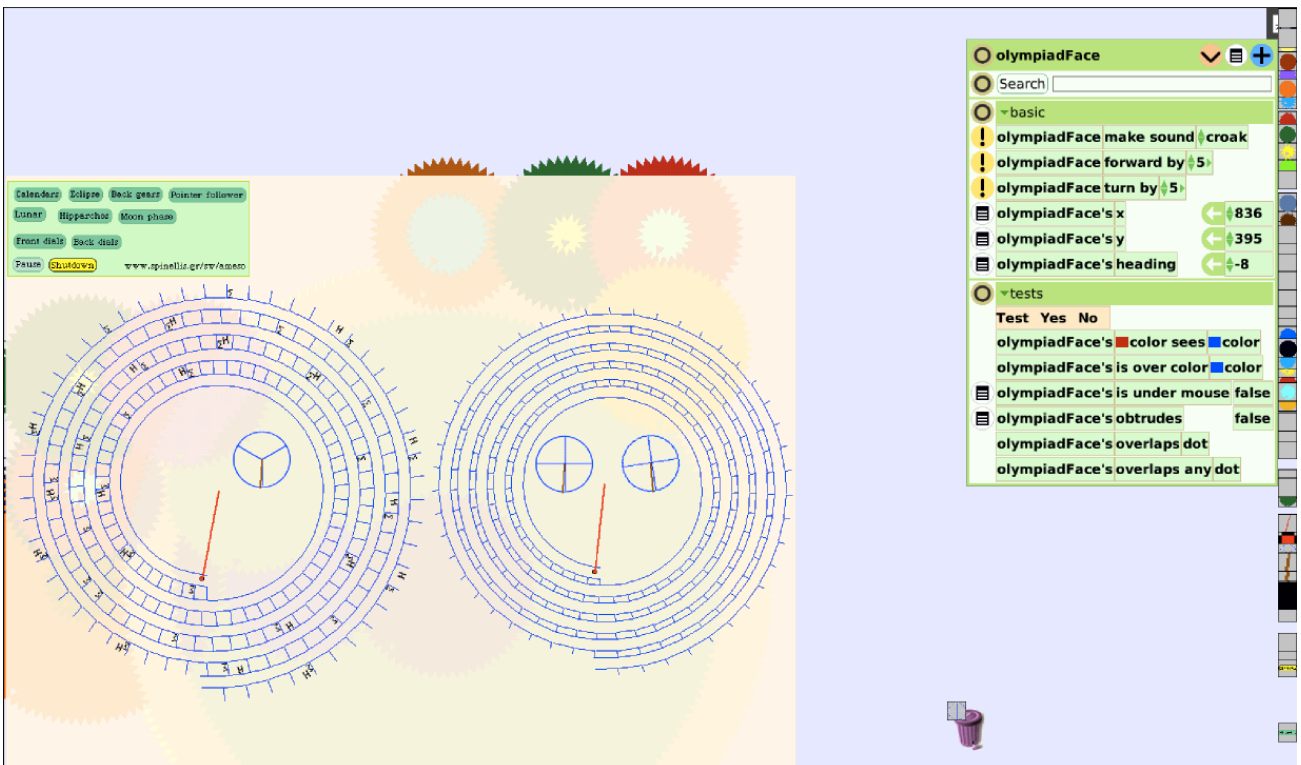

Fig.81: [Diomidis Spinellis's emulation](#). (Back view)

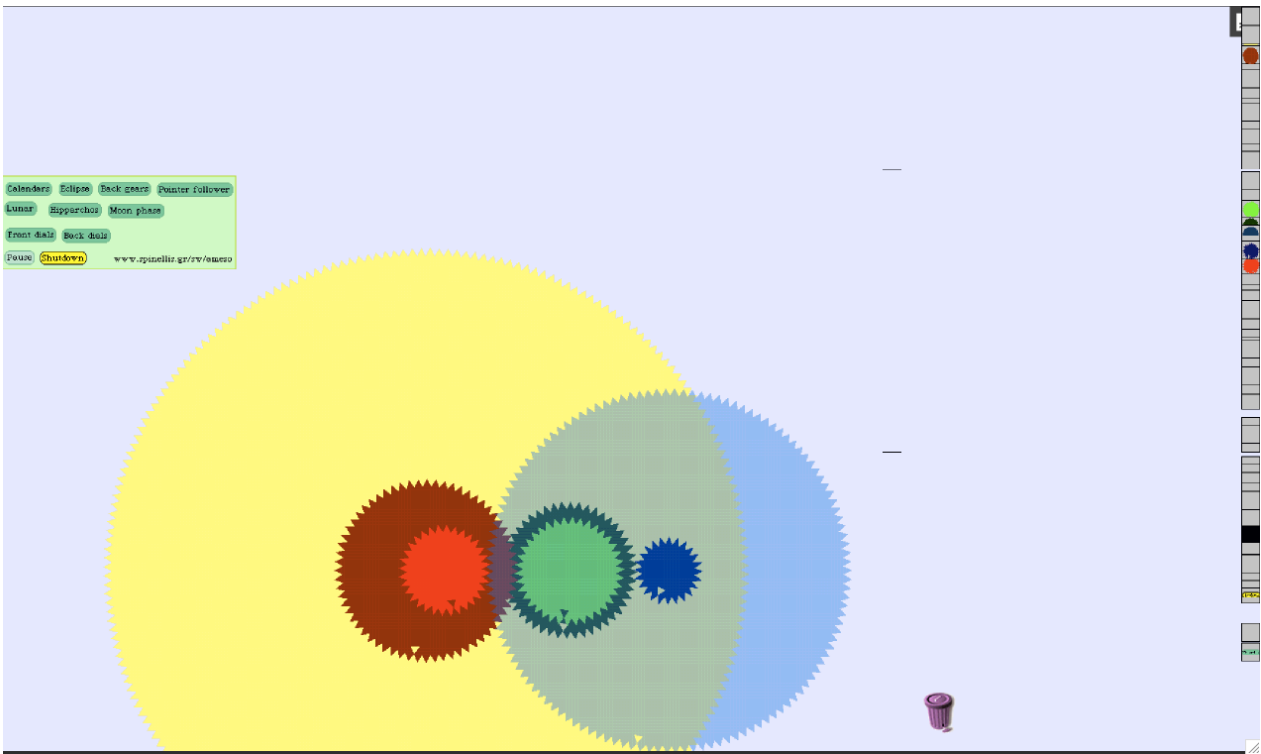

Fig.82: [Diomidis Spinellis's emulation](#). (Moon gears)

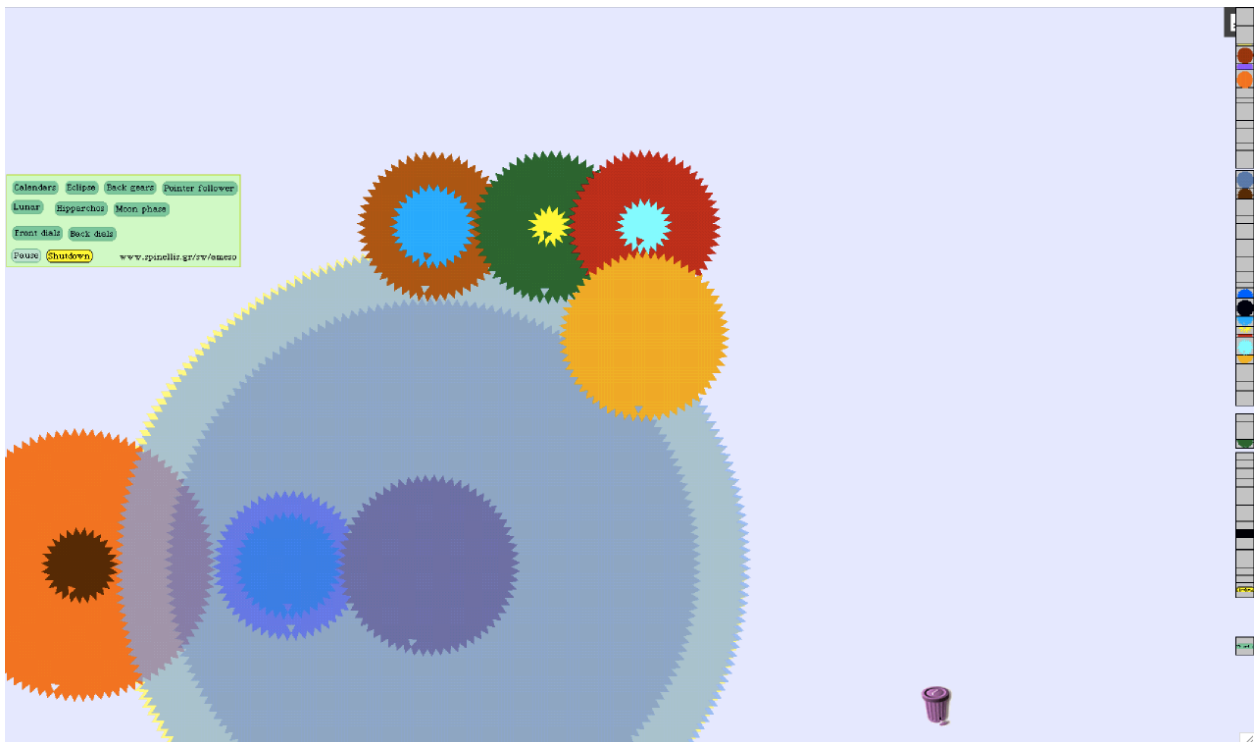

Fig.83: [Diomidis Spinellis's emulation](#). (Eclipse gears)

Antikythera Mechanism

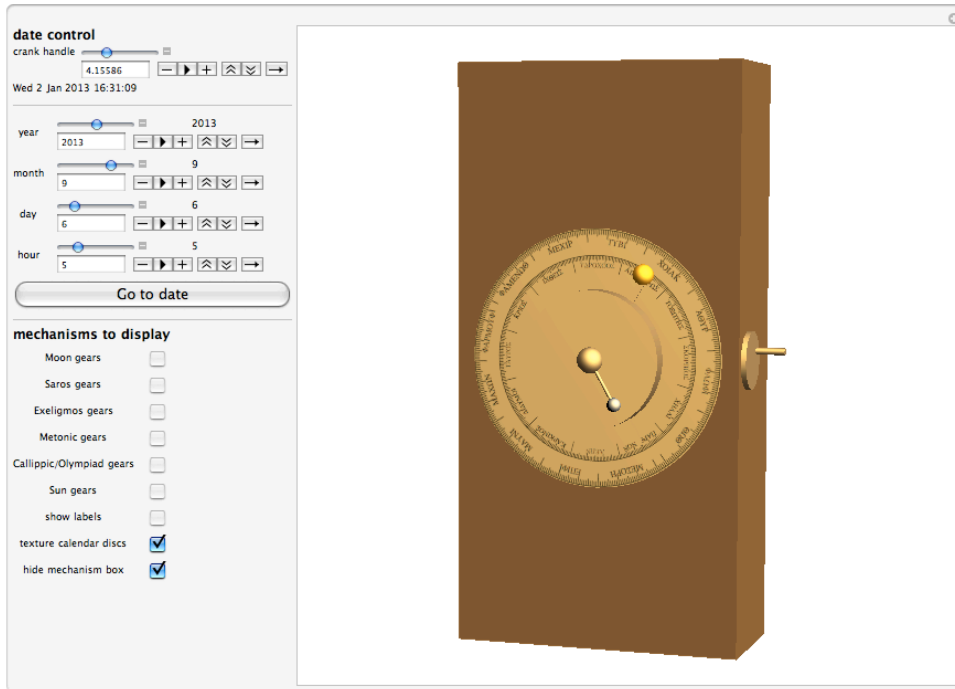

Fig.84: [Adam Goucher's simulation](#). (Front view)

Antikythera Mechanism

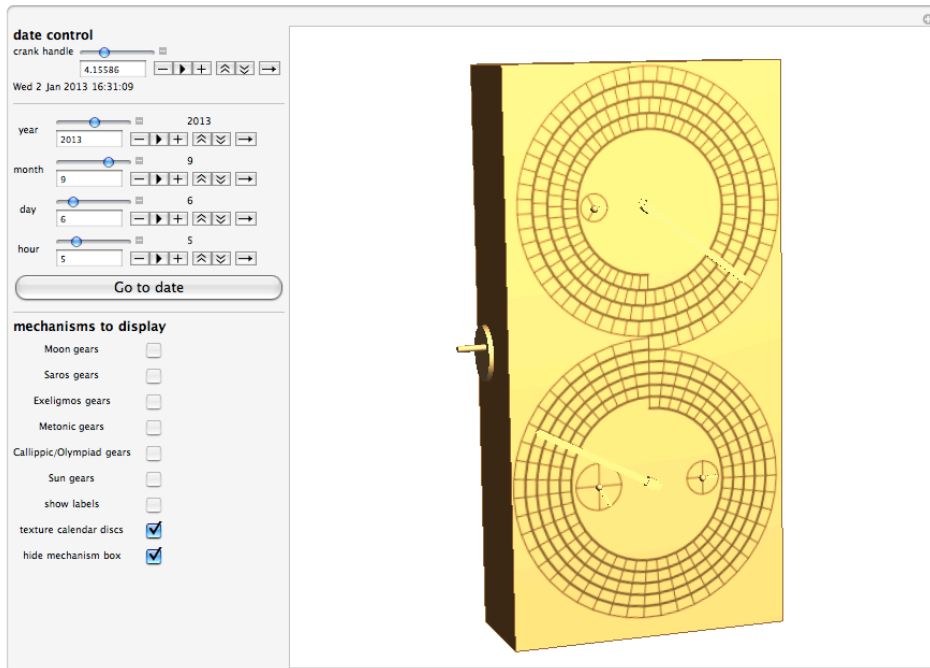

Fig.85: [Adam Goucher's simulation](#). (Back view)

Antikythera Mechanism

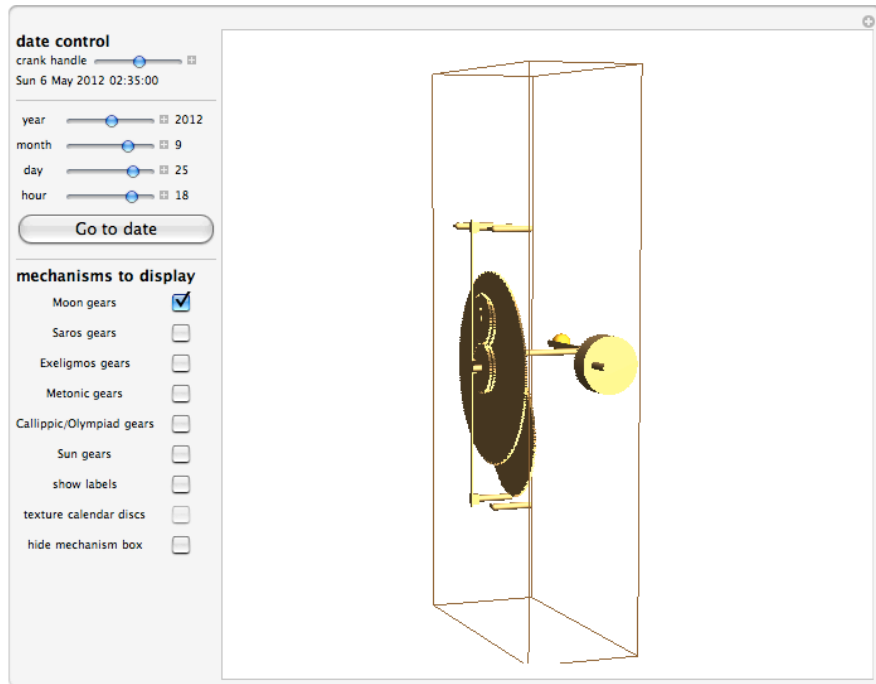

Fig.86: [Adam Goucher's simulation](#). (Moon gears)

Antikythera Mechanism

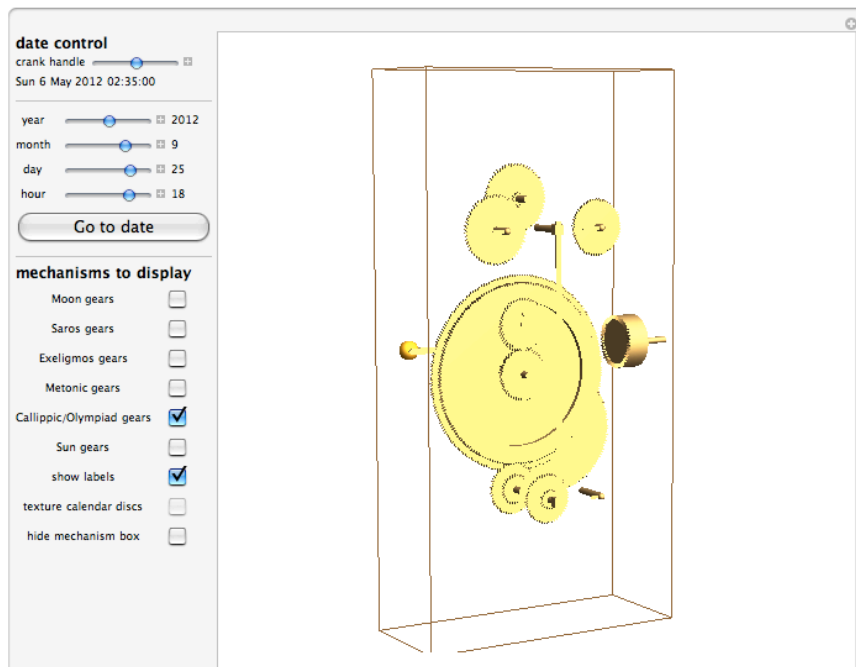

Fig.87: [Adam Goucher's simulation](#). (Callippic/Olympiad gears)

For briefness, we named the presented simulations according to the following schema presented at Table 11. By this way, we can easily refer to them during our “evaluation” process. In addition, we classify these simulations according to Alessi and Trollip (2001).

Table 11: Antikythera Mechanism simulations’s names and classification

Simulation’s name	Creator	Classification
A	Manos Roumeliotis	physical simulation
B	Olaf V.	physical simulation
C	Diomidis Spinellis	physical simulation
D	Adam Goucher	physical simulation

By “running” the listed simulations we spotted several oversights that affect negatively the learning outcome. Note that by referring to the “user” below we both consider the instructor and the learner since the listed “errors” have an effect on both, **in terms of learning and instruction**. The major ones are:

1. **Absence of corresponding text** (simulations A, B, C, D): there is no text placed near each gear or gear train as a way of identification (or at least the option of hide/show text labels). The user cannot identify which gear is which by simply using the simulation. He/she must consult an instructor, the web, a book or an article.
2. **Absence of a consistent schema for identifying AM parts** (simulations A, B, C): there is no schema for helping the user distinguish each gear train (lunar, solar, moon phase etc.). Again the user is obliged to seek information elsewhere. Although simulation D contains check boxes for choosing the presented gear trains, the used photorealism techniques make difficult to distinguish the gears or the pointers used for the eclipses (see Fig.85 & 87).
3. **The prerequisite knowledge is not provided** (simulations A, B, C, D): in order to understand the functions of the Antikythera Mechanism the user needs an “101 course” on astronomy (ancient and contemporary). This knowledge must be sought elsewhere with doubtful results.
4. **No distinction for novice and expert users** (simulations A, B, C, D): by providing a high or low fidelity simulation is not always beneficial but depends on the learner’s level of engagement and understanding about the mechanism. Thus the simulations should provide different “levels of fidelity”.
5. **No guidance is provided** (simulations A, B, C, D): the simulations are provided as an open-ended environment with no guidance about “what to do and why”. The Antikythera Mechanism is complex enough for burden the user furthermore.

6. **No built-in help** (simulation A): help is provided in the form of a separate text document and the user cannot access it unless finding the initially downloaded folder.
7. **Complex user interface** (simulations C): in many cases the platform that supports the simulation (as Spinellis's simulation in EToys) does not support a friendly environment for complicated representations like the Antikythera Mechanism. The user has to identify overlapping text boxes containing commands in Etoys programming language (see Fig.80-83, right edge).

11.3 Justifying the observed oversights

Although the listed errors seem logical from an educational prospective, it is elementary to argue **why** these missing elements are negatively effecting learning. Based on the presented e-learning guidelines at section 9.6 we provide a short list of the violated Multimedia and Simulation principles. Remember that these principles are generated from our current research-based understanding of how learning works, so any violation has a negative impact or at least does not enhance learning.

Observed Error	Violated Principle	Corresponding Guideline
Absence of corresponding text.	The Multimedia Principle	1.1 Use relevant graphics and text to communicate content.
	The Contiguity Principle	2.1 Integrate text nearby the graphic on the screen.
Absence of a consistent color schema.	The Segmenting Principle & Principle 5: Manage complexity	7.1 Present material in manageable segments controlled by the learner by using a continue or next button, rather than as a continuous unit.
The prerequisite knowledge is not provided.	The Pre-training Principle	8.1 Name key concepts and describe their characteristics before presenting the processes or procedures to which the concepts are linked.
	Principle 5: Manage complexity	13.4 Embed help that explains how the game or simulation works and/or provides domain-specific background knowledge.
No distinction for novice and expert users.	The Multimedia Principle	1.3 Be sensitive to the level of prior knowledge of your learners; the multimedia principle works best for novices.

Observed Error	Violated Principle	Corresponding Guideline
	Principle 5: Manage complexity	<p>13.2 Provide training wheels.</p> <p>13.4 Embed help that explains how the game or simulation works and/or provides domain-specific background knowledge.</p> <p>13.5 Adapt complexity to learner expertise: Learners with minimal background benefit more from simple games/simulation.</p>
No guidance is provided	Principle 4: Build in guidance and structure	12.1 Avoid discovery learning: Avoid open-ended games and simulations that require unguided exploration (Guidance Principle).
No built-in help	Principle 5: Manage complexity	13.4 Embed help that explains how the game or simulation works and/or provides domain-specific background knowledge.
Complex user interface	General HCI guidelines	General HCI guidelines.

The next two questions are easy to be answered since all the simulations focus only on presenting information (although in a wrong way); developers have intentionally or not embraced the information acquisition metaphor of learning and included only the essential for presenting information to the user (only the “presenting information” instructional phase is present). This finding in the light of our assumption at section 10.3 justifies our estimation, which is that **current simulations for the Antikythera Mechanism are not suitably designed for the use in educational (formal or not) contexts.**

12. Discussion and suggestions

During our short analysis, an interesting finding made itself clear: all present Antikythera Mechanism simulations, are not designed to fully exploit the educational potential that this artifact holds. The reviewed simulations can be used only as supportive tools in education and not as standalone educational software but still there are instructional challenges needed to be overcome. Moreover their design effects negatively or at least does not enhance users's learning, since the developers (intentionally or not) overlooked cognitive factors that affect learning. We therefore suggest the development of an educational software that:

1. **Adopts the suggested research-based e-Learning guidelines** for:
 - a. presenting information (e.g. aligned graphics and text)
 - b. taking account of users' knowledge (e.g. different levels of fidelity for expert and novices)
 - c. providing the needed knowledge (e.g. ancient astronomy)
 - d. managing complexity (e.g. a color schema for determining which gears are engaged with which gear train)
 - e. providing built-in guidance (e.g. how to use the mouse and keyboard for navigating)
2. **Embraces the knowledge construction metaphor of learning:** this requires an "all in one" approach that includes at least the first three instruction phases (presenting information, guiding the learner, practicing) as our assumption at section 9.3 suggests.

Although we have already mentioned some benefits that computer models hold over solid models at section 10.3, we would like to present at this point a list of observed facts related to the educational potential that the Antikythera Mechanism holds. These are:

1. **There is a small number of functional solid models** that can be deployed for educational purposes.
2. **AM solid models have inherent restrictions.** In particular, AM solid models:
 - a. are currently used and probably can be only used as "traditional" museum artifacts, for example in a display with very low interactivity degrees.
 - b. cannot probably be used successfully in collaborative learning.
 - c. have also restrictions related to learning itself: it is difficult to understand the functions and mechanics of this highly complex object without multimedia aids (text, additional images, animations) as in interactive media.
 - d. are difficult to built, maintain and adopt, as noted in section 10.3.

3. **Simulations for the Antikythera Mechanism are not suitably developed for the use in learning environments.**
4. **There is a very small amount of conducted research about the Antikythera Mechanism's educational potential.** In addition research delivers vague results.
5. **There is only one domain specific application**, that is in Mathematics Education (Gourtsoyannis, 2006).

13. Conclusion

As noted above, relevant literature explores the educational potential of the Antikythera Mechanism in a vast didactic context, that is as a cue point or for providing motivation to students for exploring related fields (astronomy, mathematics etc.) and additionally there is a handful of conducted research. For that reason, it would be beneficial to explore the reasons of this happening besides obvious ones. We therefore suggest that from the list above, facts 2 and 3 can be considered as **factors** affecting AM's deployment in educational contexts, while 1, 4 and 5 as **side effects**; to be more specific, these two factors act as a barrier that limits AM educational potential.

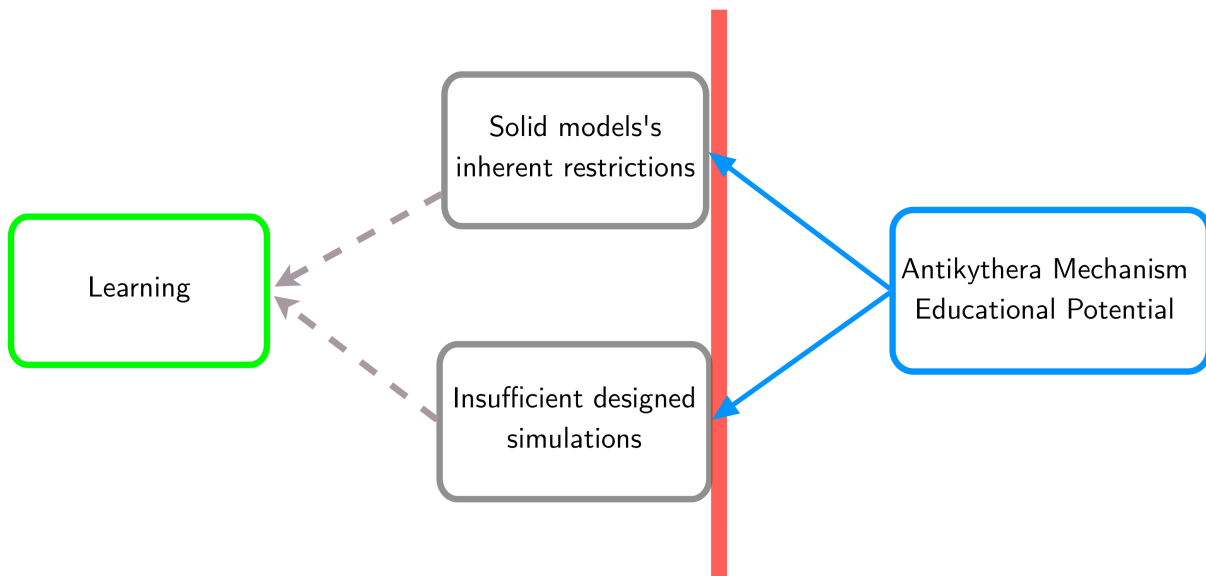

Fig.88: The three identified factors that affect AM educational potential

Such a hypothesis justifies our observations and additionally offers us a solution: simulations can be used to overcome the barrier that is created by solid models (see Figure 89). Moreover, such a postulation, suggests further AM educational implementations. In particular, well designed simulations (or other maybe an all-in-one educational apps) could help educators and learners to follow an inverse process than the one followed by the Antikythera Mechanism's maker: the maker's initial purpose was to depict the Cosmos and its known laws in a wooden box, driven by bronze gears while

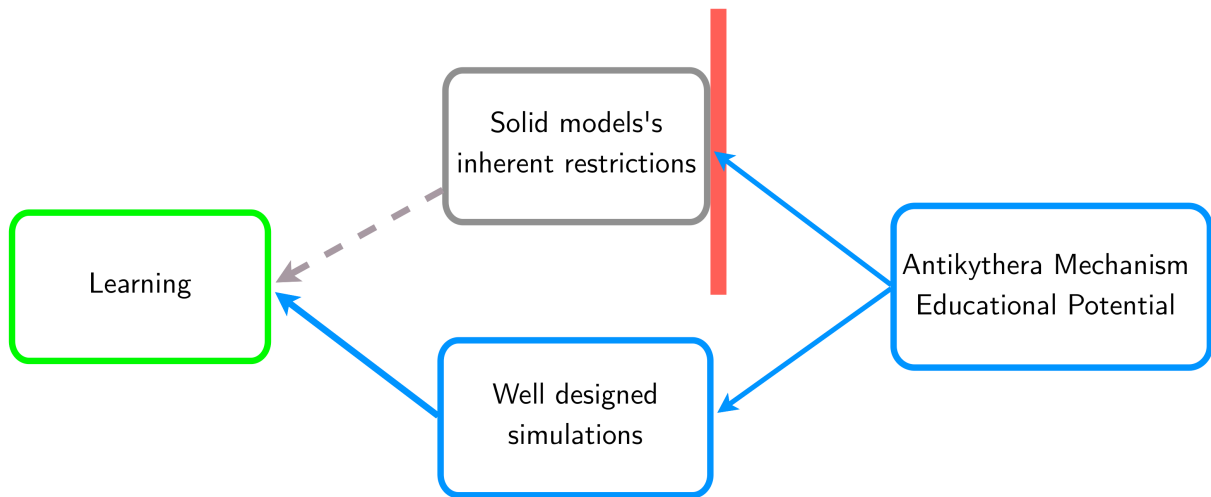

Fig.89: Overcoming the barrier by using properly designed simulations.

a simulation could be used to present how such a human model is related to the Cosmos. Such an approach could additionally present at the same time the model and the Cosmos, by depicting the model and the real movement of celestial objects.

APPENDIX - Ancient Astronomy

A. THE METONIC AND CALLIPPIC CYCLE

For ancient astronomers the option of creating an accurate lunar calendar and knowing the exact place of the Moon among the stars and the exact date for this to happen was crucial. Ancient Greeks (and prior to them Babylonians) were trying to find a way of combining the relative motion of the Sun and Moon and thus establish a relationship between the solar year and the lunar month. Although the Sun has a regular movement among the stars, Moon's motion is not so straightforward.

The Metonic cycle is named after the ancient Greek astronomer Meton of Athens who observed that a period of 19 solar (tropical) years is almost exactly equal to 235 synodic (lunar) months and consists of 6,940 days. So in 432 BC. he developed a formula for the relationship between the solar year and synodic months. His approximation for one solar year was:

$$1 \text{ year} = \frac{6,940}{19} = \left(365 + \frac{1}{4} + \frac{1}{76} \right) \text{ days}$$

A century later in 330 BC, Callippus proposed and developed a different cycle consisted of four Metonic cycles that was actually an improvement of the Metonic cycle (one full day error every 553 years). Callippus felt that a solar year was more closely to $365 + 1/4$ days so:

$$1 \text{ Callippic cycle} = 4 \text{ Metonic cycles} = 4 \times 19 \times \underbrace{\left(365 + \frac{1}{4} + \frac{1}{76} \right)}_{\substack{\text{1 Metonic year} \\ \text{1 Metonic cycle}}} = 27,760 \text{ days}$$

1 Callippic cycle

After omitting a one day from every fourth of Meton's cycles, a Callippic cycle counts exactly 27,759 days, 940 synodic months and each solar year $365 + 1/4$ days. Although the two cycles seems to refute each other, both the Metonic and Callippic cycle were significant for the establishment of a long term lunar-solar cycle.

B. SIDEREAL, SYNODIC, TROPICAL, ANOMALISTIC AND DRACONIC MONTHS

Although seem to be complicated these five months are actually five types of periods: the time that it takes for the Moon to complete a cycle. The fact that we need a reference point for defining a cycle is the actual reason of defining five different types of periods and thus “lunar” months.

MONTH	REFERENCE POINT	LENGTH IN DAYS
Sidereal Month	Position with respect to the fixed stars	27.322
Synodic Month	Phase of the Moon (Earth's - Moon's relative position)	29.531
Tropical Month	Vernal equinox	27.321
Anomalistic Month	Point on Moon's orbit (for example one of the apsides: perigee or apogee)	27.555
Draconic (or Draconitic) Month	Intercept with ecliptic plane or Node (ascending or descending)	27.212

Table : Types of Moon's periods and their length in days (Allen, 2008; Linton, 2004)

In particular (Allen, 2008):

Sidereal Month: The actual period of the Moon's orbit as measured in a fixed frame of reference is known as a sidereal month, because it is the time it takes the Moon to return to the same position on the celestial sphere among the fixed stars.

Synodic Month: The cause of moon phases is that from the Earth we see the part of the Moon that is illuminated by the Sun from different angles as the Moon traverses its orbit. So the appearance depends on the position of the Moon with respect to the Sun (as seen from the Earth). Because the Earth orbits the Sun, it takes the Moon extra time (after completing a sidereal month, i.e. a full circle) to catch up and return to the same position with respect to the Sun. This longer period is called the synodic month.

Tropical Month: It is customary to specify positions of celestial bodies with respect to the vernal equinox. Because of precession, this point moves back slowly along the ecliptic. Therefore it takes the Moon less time to return to an ecliptic longitude of

zero than to the same point amidst the fixed stars. This slightly shorter period is known as tropical month; The tropical month of the Moon is the analogous tropical year of the Sun.

Anomalistic Month: Like all orbits, the Moon's is an ellipse rather than a circle. However, the orientation (as well as the shape) of this orbit is not fixed. In particular, the position of the extreme points (the line of the apsides: perigee and apogee), makes a full circle (lunar precession) in about nine years. It takes the Moon longer to return to the same apsis because it moved ahead during one revolution. This longer period is called the anomalistic month. The apparent diameter of the Moon varies with this period, and therefore this type of month has some relevance for the prediction of eclipses, whose extent, duration, and appearance (whether total or annular) depend on the exact apparent diameter of the Moon.

Draconic (or Draconitic) Month: The orbit of the Moon lies in a plane that is tilted with respect to the plane of the ecliptic: it has an inclination of about five degrees. The line of intersection of these planes defines two points on the celestial sphere: the ascending and descending nodes. The plane of the Moon's orbit precesses over a full circle in about 18.6 years, so the nodes move backwards over the ecliptic with the same period. Hence the time it takes the Moon to return to the same node is again shorter than a sidereal month: this is called the draconic or draconitic month. It is important for predicting eclipses: these take place when the Sun, Earth and Moon are on a line. The three bodies are only on a line when the Moon is at one of the nodes. At this time a solar or lunar eclipse is possible. The draconic or draconitic month refers to the mythological dragon that lives in the nodes and regularly eats the Sun or Moon during an eclipse.

C. SAROS AND EXELIGMOS CYCLES

Saros and Exeligmos cycles are periods of time related to lunar and solar eclipses, with the latter to be a more accurate cycle. Babylonians were the first to create the Saros cycle although they didn't use this name. Around the second century BC the Greeks learned about the cycle and adopted it. For Babylonians an eclipse held a special religious meaning but for the Greeks a predicting eclipse cycle was a great opportunity of testing their geometric models for the Sun and Moon.

The **Saros cycle** is an 18 year-cycle, consisted of 223 synodic months or 242 draconic months or 239 anomalistic months. So for every cycle not only an eclipse happens at the same time but also has similar characteristics. Converting the given months into days we take: $6,585 \frac{1}{3}$ days and here is the problematic point of the Saros cycle. For every cycle the eclipse is about to happen $\frac{1}{3}$ days=8 hours later than the previous one.

In the case of an eclipse of the Sun this $\frac{1}{3}$ day means the region of visibility shifts west by 120 degrees of the way around the world, and most places from which the first eclipse was visible do not see any of the second one. In the case of an eclipse of the Moon the next eclipse might still be visible from the same location as long as the Moon is above the horizon. In order to “exile” this awkward fraction which resulted the location shift, the Greeks developed the **Exeligmos cycle**, consisted from 3 Saros cycles.

D. ZODIACAL AND SOLAR ANOMALY

Although Mercury, Venus, Mars, Jupiter and Saturn were named “planets” by ancient astronomers, they were thought as wandering stars. These strange celestial objects were observed to have two anomalies regarding their motion (Duke):

1. **First anomaly** or **Zodiacal anomaly**: each planet’s speed around the ecliptic was not constant. There was one point of minimum speed, the *apogee* and one point of maximum speed the *perigee*. Sun exhibits only the Zodiacal anomaly.
2. **Second anomaly** or **Solar anomaly**: ancient astronomers had observed that there was a special relationship between each planet’s orbit and the Sun’s position. When Mars, Jupiter and Saturn (superior planets) are 180° away from the Sun they are observed to stop their normal west-to-east motion, reverse direction, stop and then move forward again (retrograde motion). Venus and Mercury (inferior planets) although they are not observed so far from the Sun, they do follow the same pattern.

Bibliography

- Alessi, Stephen, & Trollip, Stanley. (2001). *Multimedia for Learning* (3 ed.): Boston, MA: Allyn & Bacon.
- Allen, Martin. (2008). What are the Sidereal, Synodic, Tropical, Anomalistic and Draconic months? Retrieved 7/7/2013, from <http://www.antikythera-mechanism.gr/faq/astronomical-questions/what-are-the-different-months>
- Anastasiou, M. et al. (2012 (accepted)). The astronomical events of the parapegma inscribed on the Antikythera Mechanism. *J. History Astronomy*.
- Baddeley, Alan. (1992). Working Memory. *Science*, 255, 556-559.
- Beckham, Mike (Writer). (2012). The Two-Thousand-Year-Old Computer. In M. Beckham (Producer). BBC4.
- Bromley, Allan G. (1986). Notes on the Antikythera mechanism. *Centaurus*, 29(1), 5-27.
- Bromley, Allan G. (1990). The Antikythera Mechanism. *Horol. J*, 132, 412-415.
- Carroll, J.M. (2000). *Making use: Scenario-based design of human-computer interactions*.
- Cousteau, Jacques (Writer). (1978). Diving for Roman Plunder. In C. Society (Producer), *The Cousteau Odyssey*.
- De Jong, T. (2011). Instruction based on computer simulations. In R. Mayer & P. A. Alexander (Eds.), *Handbook of research on learning and instruction*.
- De Solla Price, Derek. (1955). Clockwork before the Clock. *Horological Journal*.
- De Solla Price, Derek. (1959, June). An Ancient Greek Computer. *Scientific American*, 60-67.
- De Solla Price, Derek. (1974). Gears from the Greeks. *Journal for the History of Astronomy*, 8, 143.
- Diels, Herman. (1920). *Antik Technik* (2nd ed.). Leipzig and Berlin.
- Dix, Alan, Finlay, Janet, Abowd, Gregory, & Abowd, Russell. (2004). *Human-Computer Interaction* (3rd ed.).
- Duke, Dennis.). A Brief Introduction to Ancient Planetary Models. Retrieved 14/7/2013, from <http://people.sc.fsu.edu/~dduke/annotations.htm>
- Dumas, Frederic. (1976). *30 Centuries under the sea*. New York: Crown Publishers.
- Edmunds, MG. (2011). An initial assessment of the accuracy of the gear trains in the Antikythera Mechanism. *Journal for the History of Astronomy*, 42, 307.
- Edmunds, MG, & Freeth, Tony. (2011). Using computation to decode the first known computer. *Computer*, 44(7), 32-39.
- Edmunds, MG, & Morgan, Philip. (2000). The Antikythera Mechanism: still a mystery of Greek astronomy? *Astronomy & geophysics*, 41(6), 6.10-16.17.

- Evans, James, Carman, Christián C, & Thorndike, Alan S. (2010). Solar anomaly and planetary displays in the Antikythera mechanism. *Journal for the History of Astronomy*, 41(1), 1.
- Freeth, T, Bitsakis, Y, Moussas, X, Seiradakis, JH, Tselikas, A, Magkou, E, . . . Ramsey, A. (2006). Decoding the Antikythera mechanism: investigation of an ancient astronomical calculator. *Nature*, 444(7119), 587-591.
- Freeth, Tony. (2009). Decoding an ancient computer. *Scientific American Magazine*, 301(6), 76-83.
- Freeth, Tony. (2012). *Building the Cosmos in the Antikythera Mechanism*. Paper presented at the Proceedings of the meeting 'From Antikythera to the Square Kilometre Array: Lessons from the Ancients' (Antikythera & SKA). 12-15 June 2012. Kerastari, Greece. Published online at <http://pos.sissa.it/cgi-bin/reader/conf.cgi?confid=170>, id. 18.
- Freeth, Tony, Bitsakis, Y, Moussas, X, Seiradakis, JH, Tselikas, A, Mangou, H, . . . Ramsey, A. (2006). Decoding the ancient Greek astronomical calculator known as the Antikythera Mechanism. *Nature*, 444(7119), 587-591.
- Freeth, Tony, & Jones, Alexander. (2012). *The Cosmos in the Antikythera Mechanism*: Institute for the Study of the Ancient World.
- Freeth, Tony, Jones, Alexander, Steele, John M, & Bitsakis, Yanis. (2008). Calendars with Olympiad display and eclipse prediction on the Antikythera Mechanism. *Nature*, 454(7204), 614-617.
- Gourtsoyannis, Elias. (2006). *The Antikythera Mechanism in Mathematics Education: A Teacher's perspective*. Paper presented at the Decoding the Antikythera Mechanism, Athens, Greece.
- Gunther, Robert. (1932). *Astrolabes of th World*. Oxford.
- Hartner, Willy. (1939). In A. U. Pope & P. Ackerman (Eds.), *A Survey of Persian art from prehistoric times to the present* (Vol. 3, pp. 25-31). Oxford: Oxford University Press.
- Jones, Alexander. (2012). *The Antikythera Mechanism and the Public Face of Greek Science*. Paper presented at the "From Antikythera to the Square Kilometre Array: Lessons from the Ancients", Kerastari, Greece.
- Karo, George. (1948). Art salvaged from the sea. *Archaeology*, 1, 179-185.
- Lazos, Chrestos D. (1994). *Ο υπολογιστής των Αντικυθύρων (The Antikythera computer)*: Αίολος.
- Linton, Christopher M. (2004). *From Eudoxus to Einstein: a history of mathematical astronomy*. Cambridge University Press.
- Maltezos, M. (1934). *Εισηγητική ανακοίνωσις περί του ευρήματος των Αντικυθύρων και των ανακοινώσεων του κ. Θεοφανίδου*. Paper presented at the Praktika tes Akademias Athenon, Athens.

- Marchant, Jo. (2010a). *Decoding the Heavens: A 2,000-year-old Computer--and the Century-long Search to Discover Its Secrets*: Da Capo Pr.
- Marchant, Jo. (2010b). Mechanical inspiration. *Nature*, 468, 496-498. doi: 10.1038/468496a
- Mayer, Richard. (1996a). Learners as Information Processors: Legacies and Limitations of Educational Psychology's Second Metaphor. *31*, 151-161.
- Mayer, Richard. (1996b). Learning strategies for making sense out of expository text: The SOI model for guiding three cognitive processes in knowledge construction. *Educational Psychologist Review*, 8, 357-371.
- Mayer, Richard. (2011). Multimedia learning and games. In S. Tobias & D. Fletcher (Eds.), *Computer games and instruction*. (pp. 281–305).
- Mayer, Richard, & Clark, Ruth. (2011). *e-Learning and the Science of Instruction*.
- Miller, FJ, Sayre, Edward V, & Keisch, Bernard. (1970). Isotopic methods of examination and authentication in art and archaeology.
- Moussas, Xenophon. (2011). The Antikythera Mechanism: A Mechanical Cosmos and an Eternal Prototype for Modelling and Paradigm Study *Adapting Historical Knowledge Production to the Classroom* (pp. 113-128): Springer.
- Moussas, Xenophon. (2012). *Ο Μηχανισμός των Αντικυθήρων, Πίναξ (The Antikythera Mechanism, Pinax): Ένωση Ελλήνων Φυσικών*.
- Moussas, Xenophon, Bampasidis, Georgios, Bitsakis, Yanis, Tassios, Theodosios, Anastasiou, Magdalini, Efstathiou, Kyriakos, . . . Zafeiropoulou, Mary. (2009). The gears of the Antikythera Mechanism: an educational pathfinder to the solar system. *Proceedings of the International Astronomical Union*, 5(S260).
- Paivio, Allan. (1986). *Mental Representations: A Dual Coding Approach*.
- Rados, Constantin. (1905). *Sur les trouvailles astronomiques d' Anticythre*. Paper presented at the Comptes rendus du Congres International d'Archeologie.
- Rados, Constantin. (1910). *Peri ton thesauron ton Antikytheron: Astrolabos, anaforika orologia, mixanika dromometra, sfairai, planetaria*.
- Rediadis, Pericles. (1903). O Ex Antikytheron Astrolabos. In J. Svoronos (Ed.), *To En Athinai Ethnikon Mouseion* (Vol. 1, pp. 44-52): Beck and Berth.
- Rediadis, Pericles. (1910). *Ephimeris*, pp. cols. 157-172.
- Rehm, Albert. (1907). *Berliner Philologische Wochenschrift*, cols. 467-470.
- Roumeliotis, Manos. (2012). *Are the modern computer simulations a substitute for physical models? The Antikythera case*. Paper presented at the Proceedings of the meeting 'From Antikythera to the Square Kilometre Array: Lessons from the Ancients' (Antikythera & SKA). 12-15 June 2012. Kerastari, Greece. Published online at <http://pos.sissa.it/cgi-bin/reader/conf.cgi?confid=170>, id. 36.
- Schlachter, A. (1927). Der Globus. *Stoicheia*, 8, 53-54.
- Seiradakis, John H. (2012). *THE ANTIKYTHERA MECHANISM: From the bottom of the sea to the scrutiny of modern technology*. Paper presented at the Proceedings

of the meeting 'From Antikythera to the Square Kilometre Array: Lessons from the Ancients' (Antikythera & SKA). 12-15 June 2012. Kerastari, Greece.

Published online at <http://pos.sissa.it/cgi-bin/reader/conf.cgi?confid=170>, id. 7.

- Stais, Valerios. (1905). *Ta ex Antikythērōn eurēmata: chronologia, proeleusis, chalkous ephēvos*: Typographeion PD Sakellariou.
- Svoronos, John. (1903). *To en Athinais Ethnikon Mouseion* (Vol. 1): Beck and Barth.
- Sweller, J., & Chandler, P. (1994). Why some material are difficult to learn. *Cognition and Instruction*, 12, 185-233.
- Sweller, J., Chandler, P., Tierney, P., & Cooper, M. (1990). Cognitive load as a factor in the structure of technical material. *Journal of Experimental Psychology*, 119, 176-192.
- Theophanidis, John. (1934). Sur l'instrument en cuivre dont des fragments se trouvent au Musée Archéologique d'Athènes et qui fut retiré du fond de la mer d'Anticythère en 1902. *Praktika tes Akademias Athenon*, 9, 140-154.
- Von Daniken, Erich, & Reinl, Harald. (1968). *Chariots of the Gods*: Questar.
- Weinberg, Gladys Davidson, Grace, Virginia R, Edwards, G Roger, Robinson, Henry S, Throckmorton, Peter, & Ralph, Elizabeth K. (1965). The Antikythera shipwreck reconsidered. *Transactions of the American Philosophical Society*, 55(3), 3-48.
- Wittrock, M. C. (1989). Generative processes of comprehension. *Educational Psychologist*, 24, 345-376.
- Wright, Michael T. (2002). A planetarium display for the Antikythera Mechanism. *Horological Journal*, 144(5), 169-173.
- Wright, Michael T. (2003a). *In the steps of the master mechanic*. Paper presented at the Proc. Conf. on Ancient Greece and the Modern World, University of Patras, Greece.
- Wright, Michael T. (2003b). The scholar, the mechanic and the Antikythera Mechanism. *Bull. Sci. Instrum. Soc*, 80, 4-11.
- Wright, Michael T. (2005a). The Antikythera Mechanism: A new gearing scheme. *Bull. Sci. Instrum. Soc*, 85, 2-7.
- Wright, Michael T. (2005b). Counting months and years: The upper back dial of the Antikythera Mechanism. *BULLETIN-SCIENTIFIC INSTRUMENT SOCIETY*, 87, 8.
- Wright, Michael T. (2006a). The Antikythera mechanism and the early history of the moon-phase display. *Antiquarian Horology*, 29(3), 319.
- Wright, Michael T. (2006b). *Understanding the Antikythera mechanism*. Paper presented at the Proc. Conf. on Ancient Greek Technology, TEE Athens, Greece.
- Wright, Michael T. (2007). The Antikythera mechanism reconsidered. *Interdisciplinary Science Reviews*, 32(1), 27-43.

- Wright, Michael T. (2012). The Front Dial of the Antikythera Mechanism *Explorations in the History of Machines and Mechanisms* (pp. 279-292): Springer.
- Wright, Michael T, & Bromley, AG. (2001). Towards a new reconstruction of the Antikythera Mechanism. *Extraordinary Machines and Structures in Antiquity*, 81-94.
- Wright, Michael T, & Bromley, Allan G. (2001). Towards a new reconstruction of the Antikythera Mechanism. *Extraordinary Machines and Structures in Antiquity*, 81-94.
- Zinner, Ernst. (1943). Entstehung und Ausbreitung der Kopernikanischen Lehre.